



OPERATOR'S MANUAL



Actual vehicle appearance may vary

⚠ WARNING



Operating this ATV if you are under the age of 16 increases your chance of severe injury or death.

NEVER operate this ATV if you are under 16.

⚠ WARNING

The removal or modification of evaporative emission-related parts on this OHRV is illegal. Violators may be subject to civil and/or criminal penalties as provided under California and federal law.

p/n: 2263-662

06/23 Rev. A

Do not remove this Operator's Manual from this ATV according to the guidelines and agreement with the U.S. Consumer Product Safety Commission.

**Alterra
600**

Read this manual carefully. It contains important safety information.

Your ATV Can Be Hazardous to Operate.

A collision or rollover can occur quickly, even during routine maneuvers such as turning and driving on hills or over obstacles, if you fail to take proper precautions.

For your safety, it is important to understand and follow all the warnings contained in this Operator's Manual and the labels on your ATV prior to riding.

This Operator's Manual should be considered a permanent part of the ATV and must remain with the ATV at the time of resale. If the ATV changes ownership more than once, contact the manufacturer for proper registration information.

Labels should be considered as permanent parts of the ATV. If a label comes off or becomes hard to read, contact your authorized dealer for a replacement.

FAILURE TO FOLLOW THE WARNINGS CONTAINED IN THIS MANUAL CAN RESULT IN SERIOUS INJURY OR DEATH.

For your safety, it is important all operators be properly trained to operate an ATV. Training is available: U.S. owners, call 800-887-2887; Canadian owners, call 613-739-1535.

Particularly important information is distinguished in this manual by the following notations:



The Safety Alert Symbol means **ATTENTION! BE ALERT! YOUR SAFETY IS INVOLVED.**



WARNING

WARNING indicates a hazardous situation which, if not avoided, could result in death or serious injury.

CAUTION

CAUTION, without the safety alert symbol, is used to address practices not related to personal injury.

■ **NOTE:**

A NOTE provides key information to make procedures easier or more clear.

California Proposition 65



WARNING

The Engine Exhaust from this product contains chemicals known to the State of California to cause cancer, birth defects or other reproductive harm.

Foreword

Congratulations and thank you for purchasing an Arctic Cat All-Terrain Vehicle (ATV). Built with American engineering and manufacturing know-how, it is designed to provide superior ride, comfort, utility and dependable service.

You have chosen a quality vehicle designed and built to give dependable service. Be sure, as the owner/operator of this vehicle, to become thoroughly familiar with its basic operation, maintenance, and storage procedures. Read and understand the entire Operator's Manual before operating the vehicle to ensure safe and proper use. Always operate the vehicle within your level of skill and current terrain conditions.

This Operator's Manual is furnished to ensure that the operator is aware of safe operating procedures. It also includes information about the general care and maintenance of your ATV.

Carefully read the following pages. If you have any questions regarding this ATV, contact an authorized dealer for assistance. Remember, only authorized dealers have the knowledge and facilities to provide you with the best service possible.

Protect Your Sport

- Know all local, state/provincial riding laws,
- Respect your ATV,
- Respect the environment, and
- You will gain the respect of others.

The manufacturer advises you to strictly follow the recommended maintenance program as outlined. This preventive maintenance program is designed to ensure that all critical components on this ATV are thoroughly inspected at various intervals.

All information in this manual is based on the latest product data and specifications available at the time of printing. The manufacturer reserves the right to make product changes and improvements which may affect illustrations or explanations without notice.

Some illustrations used in this manual are used for clarity purposes only and are not designed to depict actual conditions. Because the manufacturer constantly refines and improves its products, no retroactive obligation is incurred.

Parts and Accessories

When in need of replacement parts, oil, or accessories for your ATV, be sure to use only **GENUINE PARTS, OIL, AND ACCESSORIES**. **Only genuine parts, oil, and accessories are engineered to meet the standards and requirements of your ATV. For a complete list of accessories, refer to the current ATV/ROV Accessory Catalog.**

To aid in service and maintenance procedures on this ATV, a Service Manual and an Illustrated Parts Manual are available through your local authorized dealer.

Arctic Cat and the ATV Safety Institute recommend that all ATV operators ride the appropriate-sized ATV according to age.

Category	Age (Years)	Speed Limitations in mph (km/h)	NOTES
Y-10+	10 or Older	Limited — 15 (24) Maximum — 30 (48)	Operate Under Adult Supervision
T-14	14 or Older	Limited — 20 (32) Limited — 30 (48) Maximum — 38 (61)	Operate Under Adult Supervision
G & S	16 or Older	According to Local Regulations	—

treadlightly![®]_{.org}

Arctic Cat is an Official Partner of Tread Lightly!, a U.S.-based nonprofit dedicated to promoting responsible outdoor recreation. Arctic Cat supports Tread Lightly!'s mission to protect motorized trail access and public lands through stewardship projects and responsible recreation education.

Table of Contents

Foreword.....	1
Parts and Accessories.....	1

Division I — Safety

ATV Safety Alert	4
Rider Training Course.....	5
Hangtags	6-7
Warning Labels & Information	8-9
Warnings	10-18
Prevention.....	19-22
Safe Riding Clothing and Gear	19
ATV Condition	20
First Aid and Survival	21
Active Riding	22
Sound Judgment.....	23-26
Environment.....	23
Those Around You.....	24
Equipment.....	24
Load Capacity Ratings.....	25
SpeedRack.....	25
Personal Choices.....	25
Supervision.....	27
Taking Responsibility.....	27
Inexperienced/Untrained Riders	27
Experienced/Trained Riders	27

Division II — Operation/ Maintenance

Specifications.....	28
Location of Parts and Controls.....	29
ATV Operation	30-39
Basic Operating Maneuvers.....	30
Starting a Cold Engine.....	30
Starting the Engine	30
Handling the ATV (Active Riding Techniques)	32
Tips	37

General Information	40-50
Control Locations and Functions.....	40
Power Steering.....	43
Speedometer/LCD Gauge.....	44
Diagnostic Trouble Codes.....	46
Oil Level Stick	47
Seat Latch	47
Safety Flag Bracket.....	47
Rack Loading (Front and Rear).....	47
Trailing and Towing	47
Transporting.....	48
Gasoline—Oil—Lubricant.....	48
Engine Break-In	49
Burnishing Brake Pads.....	50
General Maintenance	51-68
Maintenance Schedule.....	51
Liquid Cooling System	52
Shock Absorbers	53
General Lubrication.....	53
Hydraulic Hand Brake	57
Brake Fluid.....	57
Brake Lever Lock.....	57
Brake Hoses	57
Brake Pads	57
Rear Foot Brake.....	58
Gas Hoses	58
Protective Rubber Boots	58
Battery.....	59
Spark Plug.....	61
Throttle Cable Adjustment.....	62
Air Filter/Housing Drain	62
Draining V-Belt Cover.....	64
Tires	64
Wheels	65
Muffler/Spark Arrester	65
Light Bulb Replacement.....	66
Checking/Adjusting Headlight Aim	67
Fuses	67
Electrical Output Terminals	68
Storage Compartment/Tools	68
Preparation for Storage	69
Preparation after Storage	70
Warranty Procedure/Owner Responsibility.....	71
U.S. EPA Emission Control Statement/ Warranty Coverage (U.S. Only).....	72
California Emission Control Statement/ Warranty Coverage — OHRV (U.S. Only)	73
Maintenance Record	74
Change of Address, Ownership, or Warranty Transfer.....	75
Identification Numbers Record.....	77

Division I — Safety

AN ATV IS NOT A TOY AND CAN BE HAZARDOUS TO OPERATE.

- Always go slowly and be extra careful when operating on unfamiliar terrain. Always be alert to changing terrain conditions when operating the ATV.
- Never operate on excessively rough, slippery, or loose terrain.
- Always follow proper procedures for turning as described in this manual. Practice turning at slow speeds before attempting to turn at faster speeds. Do not turn at excessive speed.
- Always have the ATV checked by an authorized dealer if it has been involved in an accident.
- Never operate the ATV on hills too steep for the ATV or for your abilities. Practice on smaller hills before attempting larger hills.
- Always follow proper procedures for climbing hills as described in this manual. Check the terrain carefully before you start up any hill. Never climb hills with slippery or loose surfaces. Shift your weight forward. Never open the throttle suddenly or make sudden gear changes. Never go over the top of any hill at high speed.
- Always follow proper procedures for going down hills and for braking on hills as described in this manual. Check the terrain carefully before you start down any hill. Shift your weight backward. Never go down a hill at high speed. Avoid going down a hill at an angle which would cause the ATV to lean sharply to one side. Go straight down the hill where possible.
- Always follow proper procedures for crossing the side of a hill as described in this manual. Avoid hills with slippery or loose surfaces. Shift your weight to the uphill side of the ATV. Never attempt to turn the ATV around on any hill until you have mastered the turning techniques described in this manual on level ground. Avoid crossing the side of a steep hill if possible.
- Always be careful of skidding or sliding. On slippery surfaces, such as ice, go slowly and be very cautious in order to reduce the chance of skidding or sliding out of control.
- Always use proper procedures if you stall or roll backward when climbing a hill. To avoid stalling, maintain a steady speed when climbing a hill. If you stall or roll backwards, follow the special procedure for braking described in this manual. Dismount on the uphill side or to either side if pointed straight uphill. Turn the ATV around and mount following the procedure described in this manual.
- Always check for obstacles before operating in a new area. Never attempt to operate over large obstacles, such as large rocks or fallen trees. Always follow proper procedures when operating over obstacles as described in this manual.
- Never operate an ATV in fast-flowing water or in water deeper than the footrests. Remember that wet brakes may have reduced stopping capability. Test your brakes after leaving water. If necessary, apply them lightly several times to let friction dry out the pads.
- Always be sure there are no obstacles or people behind you when you operate in reverse. When it is safe to proceed in reverse, go slowly. Avoid turning at sharp angles in reverse.
- Always use the size and type tires specified in this manual. Always maintain proper tire pressure as described in this manual.
- Never improperly install or improperly use accessories on this ATV.
- Never install a twist grip throttle on this ATV.
- Never exceed the stated load capacity for an ATV. Cargo should be properly distributed and securely attached. Reduce speed and follow instructions in this manual for carrying cargo or pulling a trailer and allow greater distance for braking.
- No one under the age of 16 should operate this ATV. Some operators at the age of 16 may not be able to operate an ATV safely. Parents should supervise the use of the ATV at all times. Parents should permit continued use only if they determine that the operator has the ability to operate the ATV safely.

FOR MORE INFORMATION ABOUT ATV SAFETY, call the ATV Safety Institute at 800-887-2887 (U.S.) or 613-739-1535 (Canada).



WARNING

Indicates a hazardous situation which, if not avoided, could result in death or serious injury.

ATV Safety Alert

The U.S. Consumer Product Safety Commission has concluded that ATVs may present a risk of DEATH or SEVERE INJURY in certain circumstances:

- *** More than 2700 people, including many children, have died in accidents associated with ATVs since 2014.
- *** Many people have become severely paralyzed or suffered severe internal injuries as a result of accidents associated with ATVs.
- *** Every month thousands of people are treated in hospital emergency rooms for injuries received while riding an ATV.

You should be aware that AN ATV IS NOT A TOY AND CAN BE HAZARDOUS TO OPERATE. An ATV handles differently from other vehicles, including motorcycles and cars. A collision or roll-over can occur quickly, even during routine maneuvers such as turning and driving on hills and over obstacles, if you fail to take proper precautions.

TO AVOID DEATH OR SEVERE PERSONAL INJURY:

- * Always read the Operator's Manual carefully and follow the operating procedures described. Pay special attention to the warnings contained in the manual and on all labels.
- * Always inspect the ATV each time you use it to make sure it is in safe operating condition. Always follow the inspection and maintenance procedures and schedules described in this manual.
- * Never operate an ATV without proper instruction. Take a training course. Beginners should complete a training course.
- * Always follow these age recommendations:
 - A Y-10+ is intended for use by children age 10 or older, and a T-14 is intended for use by an operator age 14 or older.

- A child under 16 years old should never operate an ATV without adult supervision. Children need to be observed carefully because not all children have the strength, size, skills, or judgment to operate an ATV safely.
- * Never carry a passenger on an ATV. Carrying a passenger may upset the balance of the ATV and may cause it to go out of control.
- * Always avoid paved surfaces. ATVs are not designed to be used on paved surfaces and may seriously affect handling and control.
- * Never operate an ATV on a public road, even a dirt or gravel one, because you may not be able to avoid colliding with other vehicles. Also, operating an ATV on a public road may be against the law.
- * Never operate an ATV without an approved motorcycle helmet, eye protection, boots, gloves, long pants, and a long-sleeved shirt or jacket.
- * Never consume alcohol or drugs before or while operating an ATV.
- * Never operate an ATV at excessive speeds. Go at a speed which is proper for the terrain, visibility conditions, and your experience.
- * Never attempt to do wheelies, jumps, or other stunts.
- * Always be careful when operating an ATV, especially when approaching hills, turns, and obstacles and when operating on unfamiliar or rough terrain.
- * Never lend an ATV to anyone who has not taken a training course or does not have at least one year of experience operating an ATV.



Rider Training Course

The manufacturer sponsors a free “ATV RiderCourse” conducted by the ATV Safety Institute and Specialty Vehicle Institute of America to teach riding skills or to reinforce current riding skills. First-time purchasers without any previous ATV riding experience will receive a \$100 cash card from the manufacturer through the ATV Safety Institute and Specialty Vehicle Institute of America after completing the training course (U.S. owners only, one incentive, and free rider training courses for appropriate immediate family members per ATV purchase). See an authorized dealer for details or call 800-887-2887 for training course information.

In Canada, the Canada Safety Council (CSC) provides an ATV Rider’s Course to teach safe ATV operating skills. They also provide a special ATV Rider’s Course for children under 14 years of age with parental supervision. Call 613-739-1535 for more details. Also available are safety training materials from the Canadian Off-Highway Vehicle Distributors Council. Call toll-free at 877-470-2288.

Au Canada, le conseil canadien de la sécurité (CSC) offre un cours de conduite de VTT pour enseigner les habiletés d’opération sécuritaires de VTT. Un cours spécial de conduite de VTT est également offert aux enfants de moins de 14 ans avec la surveillance d’un parent. Communiquez avec le CSC en composant le: 613-739-1535 pour de plus amples informations. Matériel de formation à la sécurité est aussi disponible par Conseil Canadien des Distributeurs de Véhicules Hors Route. Composez sans frais le: 877-470-2288.



FOR MORE INFORMATION ABOUT ATV SAFETY in the U.S., call the Consumer Product Safety Commission at 800-638-2772 or the ATV Safety Institute Safety Hotline at 800-852-5344. In Canada, call the Canada Safety Council at 613-739-1535.



WARNING

Indicates a hazardous situation which, if not avoided, could result in death or serious injury.

Hangtags

This vehicle comes with hangtags containing important safety information. Anyone who rides the vehicle should read and understand this information before riding.





WARNING

Operating, servicing and maintaining a passenger vehicle or off-road vehicle can expose you to chemicals including engine exhaust, carbon monoxide, phthalates, and lead, which are known to the State of California to cause cancer and birth defects or other reproductive harm. To minimize exposure, avoid breathing exhaust, do not idle the engine except as necessary, service your vehicle in a well-ventilated area and wear gloves or wash your hands frequently when servicing your vehicle.

For more information, go to:

www.P65Warnings.ca.gov/passenger-vehicle

READ BOTH SIDES



WARNING

Electric-powered, Other Equipment

Operating, servicing and maintaining a passenger vehicle or off-road vehicle can expose you to chemicals including phthalates and lead which are known to the State of California to cause cancer and birth defects or other reproductive harm. To minimize exposure, wear gloves or wash your hands frequently when servicing your vehicle.

For more information, go to:

www.P65Warnings.ca.gov/passenger-vehicle

READ BOTH SIDES



WARNING

Indicates a hazardous situation which, if not avoided, could result in death or serious injury.

Warning Labels & Information

This vehicle comes with several labels containing important safety information. Anyone who rides the ATV should read and understand this information before riding. The labels should be considered as permanent parts of the ATV. If a label comes off or becomes hard to read, contact your authorized dealer for a replacement.

■ **NOTE:** The location and content of labels on the ATV you have purchased may differ from those shown on this page.

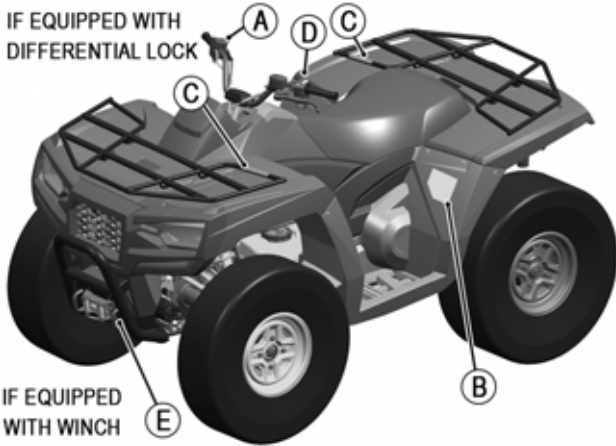

OHA-WL2021_TR_1A

A. 0411-966



C. 7411-717

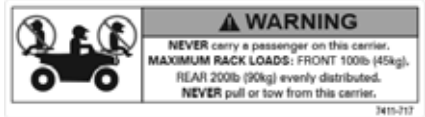

B. 9411-051



D. 1411-865



E. 0411-474



Warning Labels & Information

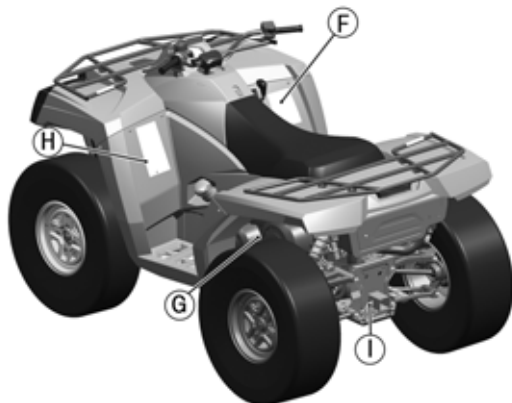

OHA-WL2021_TR_2

F. 7411-135

H. 4411-673

▲ WARNING

UNDER 16

Operating this ATV if you are under the age of 16 increases your chance of severe injury or death.

NEVER operate this ATV if you are under age 16.

▲ WARNING

NEVER operate up or down hills steeper than 25°. Avoid side hilling whenever possible.

Riding up or down hills steeper than 25° or side hilling can cause the vehicle to overturn and result in severe injury or death.

Read operator's manual for additional information. A free replacement Operator's Manual for this model is available upon written request.

7411-135

▲ WARNING

Improper ATV use can result in SEVERE INJURY or DEATH

ALWAYS USE AN APPROVED HELMET AND PROTECTIVE GEAR **NEVER USE ON PUBLIC ROADS** **NEVER CARRY PASSENGERS** **NEVER USE WITH DRUGS OR ALCOHOL**

NEVER operate:

- without proper training or instruction
- at speeds too fast for your skills or the conditions
- on public roads - a collision can occur with another vehicle
- with a passenger-passengers affect balance and steering and increase risk of losing control

ALWAYS:

- use proper riding techniques to avoid vehicle overturns on hills and rough terrain and in turns
- avoid paved surfaces - pavement may seriously affect handling and control

LOCATE AND READ OPERATOR'S MANUAL
FOLLOW ALL INSTRUCTIONS AND WARNINGS

▲ WARNING/AVERTISSEMENT

THIS VEHICLE IS AN ALL-TERRAIN VEHICLE AND IS NOT INTENDED FOR USE ON PUBLIC ROADS.
CE VÉHICULE EST UN VÉHICULE TOUT TERRAIN QUI N'EST PAS DESTINÉ À ÊTRE UTILISÉ SUR LES CHEMINS PUBLICS.

4411-673

G. 0411-426

I. 4411-550

▲ WARNING

Do not run engine without this shield in place or with drive belt removed.
Do not attempt any adjustment with engine running.

0411-426

▲ WARNING

Never exceed vehicle's towing limit. Reduce speed when towing. Read operator's manual for details.

MAXIMUM TONGUE WEIGHT:
35 lbs. (16 kg)

MAXIMUM TOWING CAPACITY:
1050 lbs. (477 kg)

4411-550



WARNING

Indicates a hazardous situation which, if not avoided, could result in death or serious injury.

Warnings

WARNING

POTENTIAL HAZARD

Operating this ATV without proper instruction.

WHAT CAN HAPPEN

The risk of an accident is greatly increased if the operator does not know how to operate the ATV properly in different situations and on different types of terrain.

HOW TO AVOID THE HAZARD

Beginning and inexperienced operators should complete the certified training course offered. They should then regularly practice the skills learned in the course and the operating techniques described in this Operator's Manual.

For more information about the training course, contact an authorized dealer or call 800-887-2887 (U.S.) or 613-739-1535 (Canada).

WARNING

POTENTIAL HAZARD

Allowing anyone under age 16 to operate this ATV.

WHAT CAN HAPPEN

Use of an ATV by children can lead to severe injury or death of the child.

Children under the age of 16 may not have the skills, abilities, or judgment needed to operate the ATV safely and may be involved in a serious accident.

HOW TO AVOID THE HAZARD

A child under 16 should never operate this ATV.

WARNING

POTENTIAL HAZARD

Carrying a passenger on this ATV.

WHAT CAN HAPPEN

Greatly reduces your ability to balance and control this ATV.

Could cause an accident, resulting in injury or death to you and/or your passenger.

HOW TO AVOID THE HAZARD

Never carry a passenger. The long seat is to allow the operator to shift positions as needed during operation. It is not for carrying passengers.



WARNING

POTENTIAL HAZARD

Attempting wheelies, jumps, and other stunts.

WHAT CAN HAPPEN

Increases the chance of an accident including a roll-over.

HOW TO AVOID THE HAZARD

Never attempt stunts, such as wheelies or jumps. Don't try to show off.



⚠ WARNING

POTENTIAL HAZARD

Operating this ATV on paved surfaces.

WHAT CAN HAPPEN

The ATV's tires are designed for off-road use only, not for use on pavement. Paved surfaces may seriously affect handling and control of the ATV and may cause the ATV to go out of control.



HOW TO AVOID THE HAZARD

Whenever possible, avoid operating the ATV on any paved surfaces including sidewalks, driveways, parking lots, and streets. If operating on paved surfaces is unavoidable, travel slowly (less than 10 mph [16 km/h]) and avoid sudden turns and stops.

⚠ WARNING

POTENTIAL HAZARD

Operating this ATV without wearing an approved helmet, eye protection, and protective clothing.

WHAT CAN HAPPEN

Operating without an approved helmet increases your chances of a severe head injury or death in the event of an accident.

Operating without eye protection can result in an accident and increases your chances of a severe injury in the event of an accident.

Operating without protective clothing increases your chances of severe injury in the event of an accident.

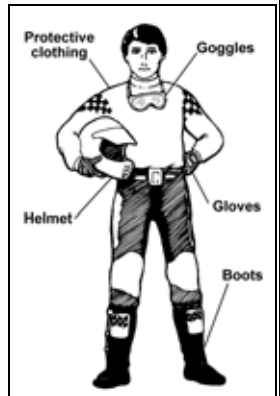

HOW TO AVOID THE HAZARD

Always wear an approved helmet that fits properly.

You should also wear: Eye protection (goggles or face shield)

Gloves

Boots

Long sleeved shirt or jacket

Long pants

⚠ WARNING

POTENTIAL HAZARD

Failure to use extra care when operating on rough, slippery, or loose terrain.

WHAT CAN HAPPEN

Could cause loss of traction or ATV control, which could result in an accident including a rollover.

HOW TO AVOID THE HAZARD

Do not operate on rough, slippery, or loose terrain until you have learned and practiced the skills necessary to control the ATV on such terrain.

Always be especially cautious on these kinds of terrain.

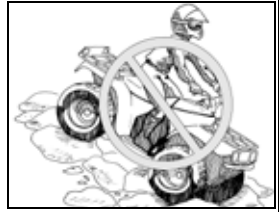

⚠ WARNING

POTENTIAL HAZARD

Operating this ATV after or while consuming alcohol or drugs.

WHAT CAN HAPPEN

- Could seriously affect your judgment.
- Could cause you to react more slowly.
- Could affect your balance and perception.
- Could result in an accident.

HOW TO AVOID THE HAZARD

Never consume alcohol or drugs before or while driving this ATV.

⚠ WARNING

POTENTIAL HAZARD

Operating this ATV at excessive speeds.

WHAT CAN HAPPEN

Increases your chances of losing control of the ATV, which can result in an accident.

HOW TO AVOID THE HAZARD

Always ride at a speed that is proper for the terrain, visibility and operating conditions, and your experience.

⚠ WARNING

POTENTIAL HAZARD

- Failure to inspect the ATV before operating.
- Failure to properly maintain the ATV.

WHAT CAN HAPPEN

Increases the possibility of an accident or equipment damage.

HOW TO AVOID THE HAZARD

Always inspect your ATV each time you use it to make sure the ATV is in safe operating condition.

Always follow the inspection and maintenance procedures and schedules described in this Operator's Manual.

⚠ WARNING

POTENTIAL HAZARD

Removing hands from handlebar or feet from footrests during operation.

WHAT CAN HAPPEN

Removing even one hand or foot can reduce your ability to control the ATV or could cause you to lose your balance and fall off the ATV. If you remove a foot from a footrest, your foot or leg may come into contact with the wheels, which could injure you or cause an accident.

HOW TO AVOID THE HAZARD

Always keep both hands on the handlebar and both feet on the footrests of your ATV during operation.

⚠ WARNING

POTENTIAL HAZARD

Improperly crossing hills or turning on hills.

WHAT CAN HAPPEN

Could cause loss of control or cause the ATV to overturn.

HOW TO AVOID THE HAZARD

Avoid crossing the side of a hill or turning on a hill whenever possible. Never attempt to turn the ATV around on any hill until you have mastered the turning technique as described in this Operator's Manual. Practice first on level ground. Be very careful when turning on any hill.

If crossing the side of a hill or turning on a hill is unavoidable:

Always follow proper procedures as described in this Operator's Manual.

Avoid hills with slippery or loose surfaces.

Shift your weight to the uphill side of the ATV.



⚠ WARNING

POTENTIAL HAZARD

Failure to use extra care when operating the ATV on unfamiliar terrain.

WHAT CAN HAPPEN

You can come upon hidden rocks, bumps, or holes without enough time to react.

Could result in the ATV overturning or going out of control.

HOW TO AVOID THE HAZARD

Go slowly and be extra careful when operating on unfamiliar terrain.

Always be alert to changing terrain conditions when operating the ATV.

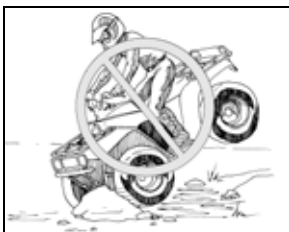

⚠ WARNING

POTENTIAL HAZARD

Going down a hill improperly.

WHAT CAN HAPPEN

Could cause loss of control or cause the ATV to overturn.

HOW TO AVOID THE HAZARD

Always follow proper procedures for going down hills as described in this Operator's Manual.

Always check the terrain carefully before you start down any hill.

Shift your weight backward.

Never go down a hill at high speed.

Avoid going down a hill at an angle that would cause the ATV to lean sharply to one side. Go straight down the hill where possible.

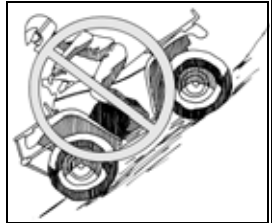

⚠ WARNING

POTENTIAL HAZARD

Turning improperly.

WHAT CAN HAPPEN

ATV could go out of control, causing a collision or rollover.

HOW TO AVOID THE HAZARD

Always follow proper procedures for turning as described in this Operator's Manual.

Practice turning at slow speeds before attempting to turn at faster speeds.

Do not turn at excessive speed.

⚠ WARNING

POTENTIAL HAZARD

Climbing hills improperly.

WHAT CAN HAPPEN

Could cause loss of control or cause the ATV to overturn.

HOW TO AVOID THE HAZARD

Always follow proper procedures for climbing hills as described in this Operator's Manual.

Always check the terrain carefully before you start up any hill.

Never climb hills with slippery or loose surfaces.

Shift your weight forward.

Never open the throttle suddenly or make sudden gear changes. The ATV could flip over backwards.

Never go over the top of any hill at high speed. An obstacle, a sharp drop, or another vehicle or person could be on the other side of the hill.



NEVER OPERATE UP OR DOWN INCLINES STEEPER THAN 25°



WARNING

POTENTIAL HAZARD

Failure to release the brake lever lock before driving the ATV.

WHAT CAN HAPPEN

Driving the ATV with the brake lever lock engaged could cause a change in handling or loss of brakes and cause an accident.

HOW TO AVOID THE HAZARD

Always release the brake lever lock before driving the ATV.

WARNING

POTENTIAL HAZARD

Operating on steep hills.

WHAT CAN HAPPEN

The ATV can overturn more easily on steep hills than on level surfaces or small hills.

HOW TO AVOID THE HAZARD

Never operate the ATV on hills too steep for the ATV or for your abilities.

Practice on smaller hills before attempting larger hills.



WARNING

POTENTIAL HAZARD

Overloading the ATV or carrying or towing improperly.

WHAT CAN HAPPEN

Could cause changes in ATV handling, which could lead to an accident.

HOW TO AVOID THE HAZARD

Never exceed the stated load capacity for the ATV.

Cargo should be properly distributed and securely attached.

Reduce speed when carrying cargo or pulling a trailer. Allow greater distance for braking.

Always follow the instructions in this Operator's Manual for carrying cargo or pulling a trailer.



WARNING

Indicates a hazardous situation which, if not avoided, could result in death or serious injury. **15**

 **WARNING**

POTENTIAL HAZARD

Improperly operating over obstacles.

WHAT CAN HAPPEN

Could cause loss of control or a collision. Could cause the ATV to overturn.

HOW TO AVOID THE HAZARD

Before operating in a new area, check for obstacles.

Never attempt to ride over large obstacles, such as large rocks or fallen trees.

When you go over obstacles, always follow proper procedures as described in this Operator's Manual.

 **WARNING**

POTENTIAL HAZARD

Skidding or sliding.

WHAT CAN HAPPEN

You may lose control of the ATV.

You may also regain traction unexpectedly, which may cause the ATV to overturn.

HOW TO AVOID THE HAZARD

Learn to safely control skidding or sliding by practicing at slow speeds and on level, smooth terrain.

On extremely slippery surfaces, such as ice, go slowly and be very cautious in order to reduce the chance of skidding or sliding out of control.

 **WARNING**

POTENTIAL HAZARD

Improperly operating in reverse.

WHAT CAN HAPPEN

You could hit an obstacle or person behind you, resulting in serious injury.

HOW TO AVOID THE HAZARD

Before you engage reverse gear, make sure there are no obstacles or people behind you. When it is safe to proceed, go slowly.

⚠ WARNING

POTENTIAL HAZARD

Stalling, rolling backwards, or improperly dismounting while climbing a hill.

WHAT CAN HAPPEN

Could result in the ATV overturning.

HOW TO AVOID THE HAZARD

Use proper gear and maintain steady speed when climbing a hill.

If you lose all forward speed:

- Keep weight uphill.
- Apply the brakes.
- Engage the brake lever lock after you are stopped.

If you begin rolling backwards:

- Keep weight uphill.
- Apply the brakes while rolling backwards.
- When fully stopped, engage the brake lever lock.
- Dismount on uphill side or to a side if pointed straight uphill.
- Turn the ATV around and mount following the procedure described in this Operator's Manual.

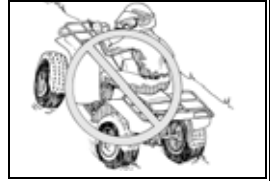

⚠ WARNING

POTENTIAL HAZARD

Operating this ATV on public streets, roads, or highways.

WHAT CAN HAPPEN

You can collide with another vehicle.

HOW TO AVOID THE HAZARD

Never operate this ATV on any public street, road, or highway, even a dirt or gravel one.

In many states it is illegal to operate an ATV on public streets, roads, or highways.

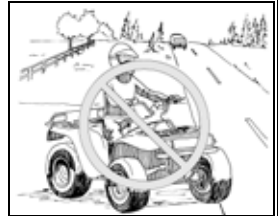

⚠ WARNING

POTENTIAL HAZARD

Operating the ATV with improper tires or with improper or uneven tire pressure.

WHAT CAN HAPPEN

Use of improper tires on the ATV or operation of the ATV with improper or uneven tire pressure may cause loss of control increasing your risk of accident.

HOW TO AVOID THE HAZARD

Always use the size and type tires specified in this Operator's Manual for this ATV.

Always maintain proper tire pressure as described in this Operator's Manual.

⚠ WARNING

POTENTIAL HAZARD

Operating the ATV through deep or fast-flowing water.

WHAT CAN HAPPEN

Tires may float, causing loss of traction and loss of control, which could lead to an accident.

HOW TO AVOID THE HAZARD

Never operate the ATV in fast-flowing water or in water deeper than the footrests.

Remember that wet brakes may have reduced stopping capability.

Test your brakes after leaving water. If necessary, apply them several times to dry out the pads.

⚠ WARNING

POTENTIAL HAZARD

Application of excessive throttle.

WHAT CAN HAPPEN

May cause wheelies, flip-overs, or loss of control resulting in serious injury or death.

HOW TO AVOID THE HAZARD

Do not accelerate rapidly or in an uncontrolled manner on any terrain. Use extra care when going uphill.

Slowly apply throttle in a controlled manner. Release throttle lever as necessary to maintain control.

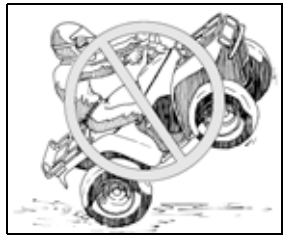

⚠ WARNING

POTENTIAL HAZARD

Operating the ATV with differential lock engaged.

WHAT CAN HAPPEN

The increased steering effort and reduced maneuverability caused by the locked differential could result in loss of control and an accident.

HOW TO AVOID THE HAZARD

Never exceed 10 mph (16 km/h) with the differential lock engaged. Always disengage the differential lock as soon as not needed for additional traction.

California Proposition 65

⚠ WARNING

The Engine Exhaust from this product contains chemicals known to the State of California to cause cancer, birth defects or other reproductive harm.

Prevention

Overview

When using an ATV, prevention is the name of the game. “Had you only known” something could go wrong, you would have prevented it. If you don’t notice your conditions and surroundings before riding your ATV, you give up control over the situation. Using ATV prevention techniques helps you forecast potential hazards before they injure you or damage your ATV.

Following the safety instructions and warnings in this manual will help you “P.A.S.S.” the safety test. P.A.S.S. stands for “**P**revention,” “**A**ctive Riding,” “**S**ound Judgment,” and “**S**upervision.” Remembering P.A.S.S. and what it stands for will help you have a safe, predictable ride every time you go out on your ATV.

Safe Riding Clothing and Gear

Always wear clothing suited to the type of riding you are doing. ATV riding requires special protective clothing which will make you feel more comfortable and reduce chances of injury.

You’ll find it important to dress correctly for ATV riding in order to prevent scraped skin and serious head injuries. It’s easy and could save you time in the long run not having to contend with an injury. Of course, it also makes sense to remember the seasons. Wear a hat under your helmet and a snowmobile suit in the winter and lighter, protective clothing in the summer. The following image shows the minimum protection you need to wear during every ride:



ATV-0004A

Helmet

Your helmet is the most important piece of protective gear for safe riding. A helmet can prevent a severe head injury. There are several types of helmets on the market, but make sure you wear a helmet that complies with the current standards of the U.S. Department of Transportation (DOT), The Snell Memorial Foundation, or the American National Standards Institute (ANSI). Helmets that comply with one or more of these agency’s standards have a sticker on the inside or outside of the helmet.

Helmets should have one of these:

1. DOT label
2. Snell label
3. ANSI Z90.1 label



These helmets should provide full-face protection.

If you drop or damage your helmet, get a new one immediately. Your helmet may not protect your head from injury if it has cracks, fissures, or other damage to its outside or core padding.

Remember, your helmet won’t do you any good if the chin strap isn’t fastened.



WARNING

Indicates a hazardous situation which, if not avoided, could result in death or serious injury. **19**

Gloves

Your hands are targets for flying objects and branches. Along with providing skin protection, gloves will shield your hands from harsh weather. Wear gloves that are weather resistant and have a gripping surface to keep them from sliding off the handlebars. Off-road style gloves with knuckle pads are the best for comfort and protection.

Boots/Ankle Protection

Wear a boot that covers the largest possible area of your leg (preferably up to your knee) and can handle significant impact. Choosing boots with low heels and a good tread will help prevent your feet from slipping off the footrests in wet or rugged conditions or getting hurt if they get hit by rocks, dirt, or branches.

Eye Protection

Wear eye protection, such as goggles, to completely surround your eyes to prevent getting dirt or other items in your eyes. Do not depend on sunglasses for proper eye protection. Sunglasses are not recommended; they don't prevent objects from flying in through the sides.

Long Pants and Long Sleeved Shirt

The goal is to protect your body from branches, long grass, airborne objects, or anything else that could scrape your skin. The more thick and durable the material, the better protection it'll provide. Riding pants with kneepads, a jersey, and shoulder pads provide the best protection.

ATV Condition

The second step in Prevention is checking the condition of your ATV. Chances are good that you'll be using your ATV in some rough terrain, and there's no way you want your brakes to go out when riding downhill. You need to check the following parts on your ATV before every ride.

1. Tires and Wheels
2. Controls and Cables
3. Lights and Electric
4. Oil and Fuel

5. Chassis
6. Miscellaneous Items

1. Tires and Wheels

Correct tire pressure is crucial. Consult the ATV Specifications section of this Operator's Manual for tire pressure guidelines. Incorrect tire pressure can cause poor handling, instability, and a loss of ATV control.

Check:

1. Tire pressure
2. Tire surface (tread and sidewalls)

While checking the tire pressure, inspect the tread and sidewalls of the tires for cracks, cuts, or other damage that could indicate they need to be replaced.

2. Controls and Cables

With the engine running and brake applied, check all transmission positions: forward, neutral, and reverse.

Check:

1. Forward
2. Neutral
3. Reverse

A. Brakes

Squeeze the hand brake lever. If it feels soft or "squishy," it could be low on fluid or have a leak — refer to the General Maintenance section of this Operator's Manual for instructions. Don't use the ATV until the brakes are operating normally.

Test the brake lever lock and see if it locks the hand brake lever into position; then disengage it to release the brake. Be sure the rear foot brake near the footrest is working; your brakes could fail during a ride if they're not maintained.

Check:

1. Hand brake lever
2. Rear foot brake
3. Brake lever lock



B. Throttle

Before starting the ATV, push the throttle lever several times. The throttle should have a free, smooth range of motion. If it seems to “stick” at any point, refer to the General Maintenance section of this Operator’s Manual for instructions. Driving your ATV with a sticking throttle can turn your leisurely ride into an unwelcome accident. Don’t drive your ATV if the throttle sticks.

Check:

1. Free, smooth range of motion

3. Lights and Electric

Turn the high beam and low beam on and off to make sure they work. At the same time, check that the taillight and brake light work. Also, check the status/warning indicators (reverse, neutral, and high/low beam) on the LCD gauge when you start the ATV. Don’t drive the ATV unless all systems are working. Check the ignition switch and emergency stop switch.

Check:

1. High beam
2. Low beam
3. LEDs (if equipped)
4. Taillight/brake light
5. Status/warning indicators
6. Ignition switch
7. Emergency stop switch

4. Oil and Fuel

Start with a full tank of gas before every ride, and while you’re at it, top off the oil. Don’t forget to check for fluid leaks around the ATV. Watch the overheat indicator to ensure the engine coolant level is adequate.

Check:

1. Gas
2. Oil
3. Fluid leaks

5. Chassis

Grass and leaves can gum-up your suspension and shocks. Clear and clean the suspension arms, shock springs, and fenders. Check smoothness by turning the handlebar full-left and full-right. Check that there is no binding, restrictions, free-play, or looseness in steering components.

Check:

1. Suspension arms
2. Shock springs
3. Fenders
4. Steering

6. Miscellaneous Items

Inspect your air filter. Look for debris or damage that may indicate you need to replace it. A clogged filter can stop an engine. Check your battery terminals for corrosion. Also, be sure to tighten any loose parts, nuts, or bolts.

Check:

1. Air filter
2. Battery
3. Tighten parts, nuts, and bolts

First Aid and Survival

You need to prepare for the unexpected. Emergencies and accidents are traumatic enough, but they’re even worse when you’re not prepared for them. At the minimum during every ATV ride, you should have the following items on board:

- Tools
- Water
- Identification
- First-aid kit

For rides that are longer in duration and distance, the following additional items are recommended:

- Cellular phone
- Maps/GPS
- Emergency kit *with flashlight and first-aid kit*



WARNING

Indicates a hazardous situation which, if not avoided, could result in death or serious injury. **21**

Tools

Routine maintenance will generally eliminate the need for emergency repairs. Riding on rough terrain could loosen nuts, bolts, and fasteners. Especially on long rides, carrying the right tools can prevent an inconvenience from becoming a crisis.

Carry these items on your ATV:

- | | |
|--------------|----------------|
| 1. Bulbs | 4. Spark plugs |
| 2. Duct tape | 5. Spare parts |
| 3. Rope | 6. Tool kit |

Water

Water is so important that you need to carry it regardless of the duration of your ride. Heat exhaustion and heat stroke can creep up suddenly and can take you out of commission. If you become dehydrated, you could find yourself physically unable to safely operate your ATV.

Identification

If something does happen to you, the emergency personnel will want to know who you are and whom to contact. It's possible you may be in no condition to give them that information. Put your I.D. in your pocket before you ride. Without it, you're anonymous.

Active Riding

Overview

"Active Riding" is the second part of "P.A.S.S." It involves an understanding of how your body weight, balance, gravity, and physical forces affect the handling of the ATV. Knowing how to shift your weight is necessary to avoid rolling or flipping the ATV.

For complete operating instructions, see ATV Operation sub-section in this manual.

Cellular Phone

It may be necessary to make an urgent phone call.

Maps/GPS (Global Positioning System)

Maps may be unnecessary when you're familiar with the area. But when you're riding on unfamiliar trails, it's good to know where you are, what's coming up, and how to get back.

Emergency Kit with Flashlight and First-Aid Kit

You'll need several items in your emergency kit including a flashlight. The matches will come in handy if you need to start a fire to stay warm. Flares are appropriate for signaling help. A first-aid kit is very important if an injury of some type should happen. A good first-aid kit should include bandages, antiseptic spray, gauze, tape, etc.

Carry these items:

- | |
|------------------|
| 1. Flashlight |
| 2. Matches |
| 3. Flares |
| 4. First-aid kit |
| 5. Money |



Sound Judgment

Overview

You are not invincible. Knowing that the first “S” in “P.A.S.S.” stands for “Sound Judgment” means you need to use yours.

Environment

The environment you operate an ATV in is often harsh and sometimes dangerous if you don't take proper precautions.

Weather

You need to consider the weather. It is dangerous to ride your ATV when the weather is bad or potentially bad. Keep abreast with weather forecasts.

Terrain

Always pay close attention to the terrain you're on, even if it is familiar to you. You can't assume that the landscape you're used to doesn't change. Changes to landscape can happen at nearly any time. Fences can be constructed and excavations dug in a short period of time. Weather, climate, and development take their toll.

The thing about terrain is that sometimes you don't know it's changed until you get there. Whether it's familiar or not, check out your surroundings before and during your ride.

Night Riding

Riding at night can be very hazardous. Obstacles and other hazards (that are easily identified during daytime) are much more difficult to see and avoid. When night riding, make sure the lights are properly adjusted and in good working order. Reduce speed; do not over-drive the headlights. Never travel in an unfamiliar area or blaze a new trail at night. Always carry a flashlight or flare for signaling an emergency.

Paved Surfaces

Avoid whenever possible. The ATV isn't designed for pavement. Its handling becomes more difficult on paved surfaces. If operating on paved surfaces is unavoidable, travel slowly (less than 10 mph [16 km/h]) and avoid sudden turns and stops.

Trail Riding

Use sound judgment when trail riding; that means riding on a trail that fits your ability level. If the trail is pretty rugged, standing up on your footrests will make it easier for you to endure the rough terrain.

Make yourself visible by using headlights and taillights, and pull completely off the trail if you need to stop.

Out-sloped trails (trails that slant to allow rain to run off) make trail riding a bit more challenging. Keep your weight shifted into the slope.

It also helps to know which trails you can legally ride and who else might be on those same trails. These are signs currently used in some areas to designate trail types and restrictions.

Trail Signs



ATV-0068A



WARNING

Indicates a hazardous situation which, if not avoided, could result in death or serious injury. **23**

Those Around You

People do all kinds of things that you can't predict or control.

Riding Companions

Leave a lot of space between you and other riders, especially in dusty and dirty conditions, because it'll be difficult to see the riders in front of you stopping.

Do not carry a passenger on any ATV designed for single-rider use. These ATVs do not have appropriate equipment (handholds, footrests, etc.) to accommodate riders. Additionally, the added weight and weight shift can make the vehicle difficult to control.

Other Vehicles

Depending on where you're riding, you might encounter other ATVs, bikes, or motor vehicles on public lands. Respect the presence of cars if you're crossing roads or riding in public areas and make yourself be seen. If you can't see other vehicles coming, that means you're invisible, too.

Hikers

With the renewed interest in hiking, camping, and other outdoor activities, people can show up in remote areas where you would never expect them. For their sake, keep your eyes open.

Animals and Nature

Respect the outdoors that you love. Don't use your ATV to chase animals or birds. Drive around young trees rather than over them. Keep clear of streams and ditches with standing water.

Tread Lightly and leave it as you found it.

Equipment

The last thing you expected was that your ATV would break down in the middle of the field ... it's usually so reliable that sometimes you forget the ATV has its limits.

ATV Maintenance

You have to maintain your ATV. The General Maintenance section of this Operator's Manual tells you about taking care of your ATV. If, at any time, abnormal noises, vibrations, or improper functioning of any component of this ATV is detected, **DO NOT OPERATE THE ATV**. Take the ATV to an authorized dealer for inspection and adjustment or repair.

Cargo Limitations

One reason why passengers are prohibited on ATVs is because their presence throws off the weight and balance of the ATV. Cargo can do the same if it weighs too much. Limit the ATV to the load capacity ratings identified in the following chart for the particular model being operated. So if you're weighing in at over 215 lb (97 kg) when you ride, leave some of that extra cargo at home. The combined weight limit, including you, your rack cargo, and your trailer, is a specified amount, so consult the ATV Load Capacity Ratings chart and monitor it carefully.

Extra weight on the ATV will also throw you off balance if it's not distributed evenly, side-to-side and front-to-rear. If you have 160 lb (73 kg) on the rear rack only and you're heading up an incline, shifting your own weight forward isn't going to do enough to compensate for that cargo sitting over the back tires.

Cargo has such a huge affect on ATV handling that you need to pay a lot of attention to your speed. Even on really level areas, you should keep it under 10 mph (16 km/h) if you've got a trailer attached. Avoid uneven terrain. Also, consider that your braking distance is going to increase with the more weight you carry.

Think about these when dealing with cargo:

1. Rack weight limit
2. Trailer weight limit
3. Weight distribution
4. ATV speed



Load Capacity Ratings

ITEM	Specifications	
	(lb)	(kg)
Maximum Load Capacity	515	233
Front Rack (max)	100	45
Rear Rack (max)	200	91
Tongue Weight	35	16
Rear Rack and Tongue Weight (max)	200	91
Towing Capacity	1050	477

Maximum Load Capacity — Total weight of operator, accessories, tongue weight, and cargo on front and rear racks.

Tongue Weight — Weight on trailer tongue.

Rear Rack and Tongue Weight — Total weight on trailer tongue, SpeedRack, and rear rack.

Towing Capacity — Total weight of trailer and all cargo in the trailer.

■ **NOTE: Tongue and accessory weight (winch, snowplow, SpeedRack, gun scabbard brackets, etc.) must be included as part of the front and rear rack weights.**

SpeedRack

When installing SpeedRack accessories, read and carefully follow the instructions provided in each kit.

■ **NOTE: Use extra caution when operating an ATV with additional loads such as accessories and/or cargo. Handling of the ATV may be adversely affected. Reduce speed when adding additional loads.**

WARNING

POTENTIAL HAZARD

Overloading the ATV or carrying or towing cargo improperly.

WHAT CAN HAPPEN

Could cause changes in ATV handling, which could lead to an accident.

HOW TO AVOID THE HAZARD

Never exceed the stated load capacity for the ATV.

Cargo should be properly distributed and securely attached.

Reduce speed when carrying cargo or pulling a trailer. Allow greater distance for braking.

Always follow the instructions in this Operator's Manual for carrying cargo or pulling a trailer.

Personal Choices

A safe, enjoyable ride is dependent on many personal choices. An ATV, like all motorized vehicles, can be dangerous to operate if you choose to ignore safety precautions, take unnecessary chances, or ride beyond your ability or your vehicle's capability. Don't allow the thrill of freedom or adventure to affect your ability to make good, safe choices.

Alcohol and Drug Consumption

It's extremely dangerous and often illegal to drink alcoholic beverages and ride.

Substances to avoid when riding:

1. Alcohol
2. Over-the-counter or prescription drugs
3. Illegal/mood altering drugs



WARNING

Indicates a hazardous situation which, if not avoided, could result in death or serious injury. **25**

Alcohol Effects*

The Number of Drinks that Impair Mental and Physical Abilities

1-2 DRINKS

Mental processes such as restraint, awareness, concentration, and judgment affected; reaction time slowed; inability to perform complicated tasks.

3-4 DRINKS

Depth perception, glare recovery, eye movement, and focus affected; decreased judgment and control.

5+ DRINKS

Coordination deteriorates, loss of critical judgment, and impaired memory and comprehension.

**According to the ATV Safety Institute.*

Be aware of prescription and over-the-counter medications. Drowsiness and impaired judgment can be caused by a wide variety of medications. The same is true of allergy, cold, flu, and headache medications. Your physical size and weight can't protect you ... just one antihistamine tablet can affect your judgment.

Don't use alcohol or drugs before or during your ATV ride.

Your Physical Condition

Your physical condition is critical to safe ATV operation. Don't ride when tired and consider your health when planning longer rides.

Don't ride:

1. When you're tired

Reckless Riding

Where excessive or high speed is a factor, the potential for personal injury is greatly increased. Ride within reason and your skill level. Avoid maneuvers that are reckless. Don't show off.

Laws and Regulations

Any police officer will tell you that ignorance of the law is no defense. Your best defense is to check out your local, state, or provincial ATV laws before riding. It'll also make sure that you can continue to ride in your favorite areas. The quickest way to have a land area closed is by riding over the regulations.

Group Behavior

When riding in a group, it is human nature to try to keep up with or out-do those around you. We can all be competitive and that can lead to risk taking resulting in serious injury or equipment damage. Know your limitations and don't be afraid to slow the pace down.



Supervision

Overview

You're responsible for supervising those who ride your ATV. Your wisdom is valuable ... it'll bring them all back safely — your friends, your family, your relatives, and your ATV. It's crucial that you consider yourself a supervisor for all riders of your ATV. Whether you accept responsibility or not, the truth is that you are responsible for others riding your ATV.

Taking Responsibility

You're to the final "S" in P.A.S.S.: "Supervision." You've just gone through the manual, and you've seen what's involved. That puts you in a good position to be confident about what you know. So now it's time to use your knowledge and supervise others who ride your ATV.

Inexperienced/Untrained Riders

You can't let people ride your ATV who don't know what they're doing. Unless they've had over a year of experience with ATV riding or taken an ATV training course, it's your responsibility to keep them off your ATV. It can be dangerous (especially for underage children) — all the more reason for you to be firm.

Experienced/Trained Riders

If anyone is going to borrow your ATV, you are responsible for their supervision. Before they ride, have them take the training course, have them watch the safety video, have Operator's Manual, and train them.

ATVs are all a little different from the handling to the stability to the controls. So regardless of how much experience your family members have with ATVs, they don't have experience with **your** ATV. Let experienced riders get familiar with your ATV — show them the basics before they take off. You don't want it on your conscience that someone got hurt because you didn't tell them how to use your ATV.

Remember that regardless of experience, you should never let anyone under the age of 16 operate your ATV.

The manufacturer and the ATV Safety Institute recommend that all ATV operators ride the appropriate-sized ATV according to age.

Category	Age (Years)	Speed Limitations in mph (km/h)	NOTES
Y-10+	10 or Older	Limited — 15 (24) Maximum — 30 (48)	Operate Under Adult Supervision
T-14	14 or Older	Limited — 20 (32) Limited — 30 (48) Maximum — 38 (61)	Operate Under Adult Supervision
G & S	16 or Older	According to Local Regulations	—



WARNING

Indicates a hazardous situation which, if not avoided, could result in death or serious injury. **27**

Division II — Operation/Maintenance Specifications

ENGINE	
Type	Four-Cycle/Liquid Cooled
Bore x Stroke	94 mm x 86 mm (3.70 x 3.38 in)
Displacement	597 cc (36.43 cu in)
Spark Plug Type	NGK LKR7E
Spark Plug Gap	0.7-0.8 mm (0.027-0.031 in)
CHASSIS	
Length (Overall)	Black Hills Edition: 221 cm (87 in) All Other Models: 209.3 cm (82.4 in)
Height (Overall)	Black Hills Edition: 127 cm (50 in) All Other Models: 125.7 cm (49.5 in)
Width (Overall)	124.5 cm (49 in)
Suspension Travel (Front/Rear)	23 cm (9 in)
Tire Size (Front/Rear) — Base, XT	25 x 8-12 / 25 x 10-12
Tire Size (Front/Rear) — LTD, SE 27"	27 x 9-14 / 27 x 11-14
Tire Size (Front/Rear) — LTD, SE 26"	26 x 9-14NHS / 26 x 11-14NHS
Tire Size (Front/Rear) — Black Hills Edition	28 x 10-14 / 28 x 10-14
Tire Inflation Pressure (No Load)	48.3 kPa (7.0 psi)
Tire Inflation Pressure (Load \geq 143 kg [315 lbs] to max. 233 kg [515 lbs])	68.9 kPa (10.0 psi)
Brake Type	Hydraulic w/Brake Lever Lock and Rear Foot Brake
MISCELLANEOUS	
Dry Weight (Approx.)	345 kg (760 lb)
Gas Tank Capacity	20.06 L (5.3 U.S. gal)
Coolant Capacity	2 L (2.1 U.S. qt)
Differential Capacity	270 mL (9.1 fl oz)
Rear Transaxle Capacity	1200 mL (40.5 fl oz)
Engine Oil Capacity (Approx.)	2.35 L (2.5 U.S. qt)
Gasoline (Recommended)	87 Octane Regular Unleaded
Engine Oil (Recommended)	ACX All Weather (Synthetic)
Front Differential Lubricant (actuator on gas cap side)	SAE-Approved 80W-90 Hypoid
Rear Transaxle Lubricant/Front Differential Lubricant (actuator on foot brake side)	Synthetic Extreme Pressure Transaxle Fluid
Brake Fluid	DOT 4
Taillight/Brake Light	LED
Headlight — Base, XT	12 V — 60 W/55 W Halogen
Headlight — LTD, SE, Black Hills Edition	12 V — 60 W/55 W Halogen with LED accents
Starting System	Electric

Specifications subject to change without notice.

Location of Parts and Controls

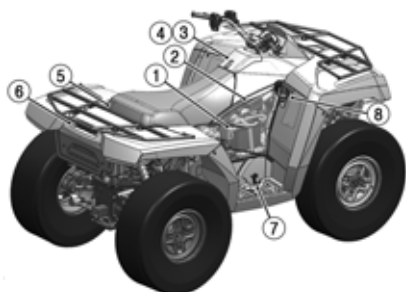

OHA001



OHA002A

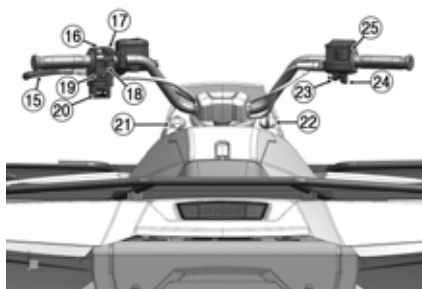

OHA003

1. Battery
2. Power Distribution Module
3. Storage Compartment
4. Operator's Manual Location
5. Seat Latch
6. Taillight
7. Rear Foot Brake
8. Shift Lever
9. Gas Cap
10. Headlights
11. Winch (if equipped)
12. Radiator/Coolant Access Panel
13. LCD Gauge
14. Brake Lever Lock
15. Hand Brake Lever
16. Headlight Switch
17. Starter Button
18. Emergency Stop Switch
19. Reverse Override Switch
20. Winch Switch (if equipped)
21. DC Power Outlet
22. Key Switch
23. Throttle Limiter
24. Throttle Lever
25. Drive Select Switch

■ **NOTE:** Your ATV may differ slightly from those shown in this manual.

ATV Operation

Basic Operating Maneuvers

Active riding and basic maneuvers are the foundation of your ATV ride. Without basic skills, it's impossible to move to this level — active riding. These are your basic maneuvers:

- Mounting the ATV
- Starting the Engine
- Starting a Cold Engine
- Shifting
- Braking/Stopping
- Parking
- Dismounting the ATV

Mounting the ATV

To get seated:

1. From the left side, grab the left-side handlebar, apply the brake, and put your left foot on the footrest.
2. Grab the right-side handlebar.
3. Swing your leg over the seat and set your right foot down on the right-side footrest.
4. Get seated in a comfortable position.
5. Always keep your feet planted on the footrests.

Starting the Engine

Always start with the ATV on a flat, level surface. Carbon monoxide poisoning can kill you, so keep your ATV outside while it's running. Follow these steps to start it up:

1. Mount the ATV and sit down.
2. Engage the brake lever lock.
3. Rotate the ignition switch key to the first position (ON).
4. Move the emergency stop switch to the RUN position (see page 42 for emergency stop switch location).
5. Press the starter button.

CAUTION

Do not run the starter motor for more than 8 seconds per starting attempt. The starter motor may overheat causing severe starter motor damage. Allow 15 seconds between starting attempts to allow the starter motor to cool.

6. Let the engine warm up.

Starting a Cold Engine

■ **NOTE:** It is very important not to touch or compress the throttle lever during the starting procedures.

1. Turn off all electrical accessories (lights, etc.); then rotate the ignition switch key to the first position (ON) leaving the headlights OFF.

■ **NOTE:** N or P is displayed on the LCD gauge. If vehicle is in gear (gauge displays L, H or R), the brake must be held to start.

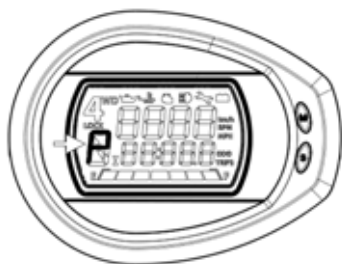

OHA041

2. Press on the starter button.

CAUTION

Do not run the starter motor for more than 8 seconds per starting attempt. The starter motor may overheat causing severe starter motor damage. Allow 15 seconds between starting attempts to allow the starter motor to cool.

■ **NOTE:** Do not touch the throttle lever until the engine has run for at least 3 minutes.

3. Allow the engine to warm up for approximately 2-3 minutes or until the ATV will accelerate without hesitating.

Shifting

1. To engage any gear position from park, move the shift lever upward to the desired position. R (reverse), N (neutral), H (high range), or L (low range).



OHA004

2. To engage the P (park), come to a complete stop; then shift the transmission into park.
3. Selected gear: L, H, N, R or P will display on gauge.

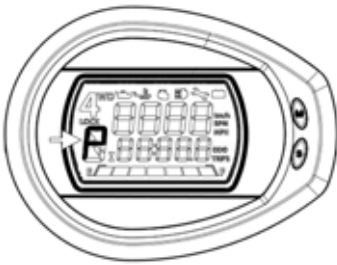

OHA041

■ **NOTE:** The high range is for normal riding with light loads. The low range is for carrying heavy loads or trailer towing. Compared to HIGH range, the LOW range position provides slower speed and greater torque to the wheels.

CAUTION

Always shift into low range when operating on wet or uneven terrain, when towing or pushing heavy loads, and when using a plow. Failure to follow this caution may result in premature V-belt failure or in damage to related drive system components.

CAUTION

Always come to a complete stop before attempting to shift from one range to the other or into reverse. Always shift on level ground, or engage the brake lever lock before shifting into another range or into reverse.

Braking/Stopping

Always allow plenty of room and time to stop safely. Sometimes quick stops are inevitable, so always be prepared. Whether you're stopping slowly or stopping quickly, do the following:

1. Squeeze the brake lever on the left handlebar to apply both the front and rear brakes.
2. If your wheels lock, release them for a second; then apply them again.
3. Never "ride" the brake. Even maintaining minimal pressure on the brake lever will cause the brake pads to drag on the disc and may overheat the brake fluid.

⚠ WARNING

Excessive repetitive use of the hydraulic brake for high-speed stops will cause overheating of the brake fluid and premature brake pad wear which will result in an unexpected loss of brakes.

⚠ WARNING

Use only approved brake fluid. Never substitute or mix different types or grades of brake fluid. Brake loss can result. Check brake fluid level and pad wear before each use. Brake loss can result in severe injury or even death.

Parking

Parking involves following the previous rules for braking; then:

1. After the vehicle stops, shift into park.

- Turn off the ignition switch when fan stops. See Shutting Down Properly on page 39.

WARNING

Parking on any incline can allow the vehicle to move, causing injury or damage.

CAUTION

Parking on any incline puts excessive loads on shifting mechanisms and can cause hard shifting and/or stress on parts.

If parking on a hill or any incline is the only alternative, use caution and follow these procedures after the vehicle stops:

- Engage the brake lever lock.
- Shift into park.
- Turn off the ignition switch when fan stops. See Shutting Down Properly on page 39.
- Verify vehicle is in park before dismounting.

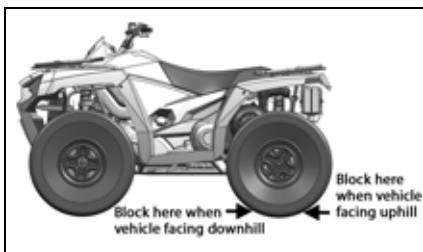

OHA005

- Block rear wheels on the downhill side.

Dismounting the ATV

After you've followed the procedure for parking, it's time to dismount:

- Double check that the brake lever lock is engaged.
- Swing your right leg over to the left side of the seat.
- Step to the ground on the left side of the ATV.

Handling the ATV (Active Riding Techniques)

Active riding involves moving your body. You must learn to lean and shift your weight into your turns to maintain control.

Your safety depends on using safe riding techniques. Statistics from the U.S. Consumer Product Safety Commission (CPSC) say that inexperienced riders who don't use safe riding techniques are **13 times more likely to have an ATV accident** than riders who have more than one month of experience.

Safe riding techniques include:

- Riding
- Leaning, Weight Shift, and Balance
- Wide Turns
- Sharp Turns
- K-Turns
- Riding Uphill
- Riding Downhill
- Sidehilling/Traversing
- Swerving
- Crossing Obstacles

Riding

Once the engine's warm, the ATV is ready to go.

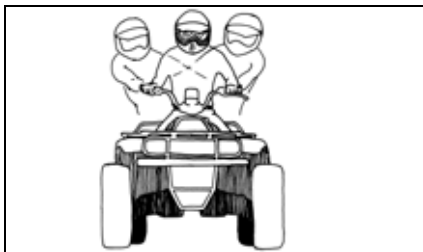

ATV-0012

- Keep your feet on the footrests and both hands on the handlebar.
- Hold the brake lever, and release the brake lever lock.
- Shift into gear.
- Release the brake slowly and apply the throttle.

Leaning, Weight Shift, and Balance

When you turn, the trick is to move forward and slide over to the side of the seat that's on the inside of the turn. Support your body weight on the outside footrest. At the same time, lean your body to the inside of the turn. Pay attention to the handling — if you feel the tires coming off the ground, reduce speed, shift more of your body weight to the side that's lifting, and make the turn wider if possible.

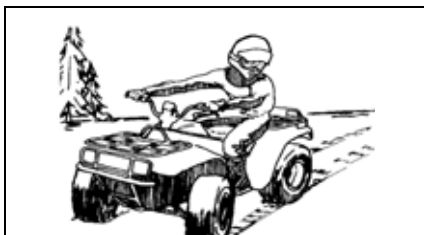

ATV-0013



ATV-0024



ATV-0025

Wide Turns

Many ATV accidents happen during turns. If you don't understand turning techniques, it's easy for the ATV to get away from you by losing traction, plowing, or tipping. Use this method for wide turns:



ATV-0046



ATV-0045



ATV-0044

1. Ease off the throttle as you approach the turn to slow down.
2. Use the principles of leaning, weight shifting, and balancing — shift your body weight to the inside of the turn.
3. Gradually increase your speed as you come out of the turn.

Sharp Turns

After mastering wide turns, practice the advanced skill of sharp turns.



ATV-0038



ATV-0039



ATV-0040

1. Ease off the throttle as you approach the turn to slow down.
2. Use the principles of leaning, weight shifting, and balancing — shift your body weight to the inside of the turn.
3. You might have to lean into the turn more than you do in a wide turn.
4. If shifting your weight and balance aren't enough to keep the ATV tires on the ground, straighten out the handlebar as much as you can.
5. Gradually increase your speed as you come out of the turn.

K-Turns

Use K-turns if you accidentally stall while riding uphill; you need to take action before the ATV rolls backward down the hill.

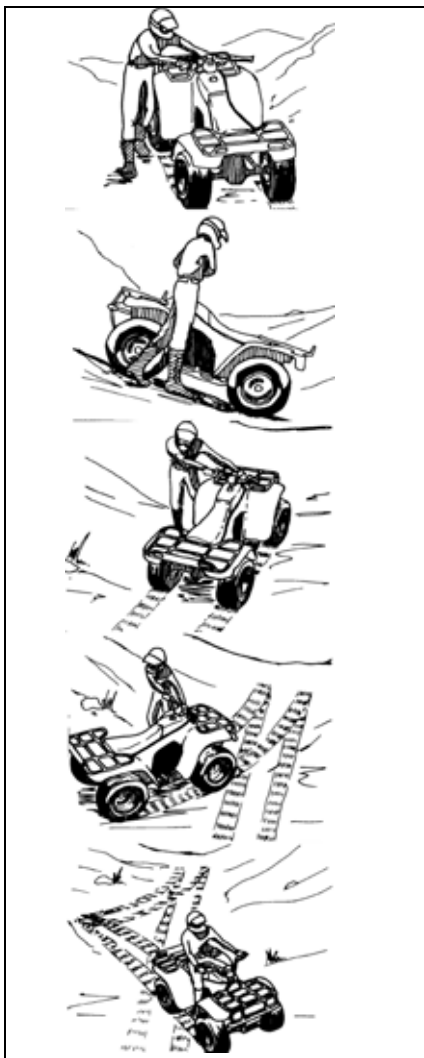

ATV-204

1. Stop where you are, apply the brakes, and shift to neutral.
2. Shut off the engine.
3. Keep your body weight shifted forward.

4. Get off the ATV on the uphill side.
 5. If you're to the left of the ATV, turn the handlebar all the way left.
 6. Partially release the brake, but lightly hold the brake lever.
 7. Let the ATV roll to your right side until it faces slightly downhill.
 8. Reapply the brakes.
 9. Get back on the ATV from the uphill side, and keep your weight shifted uphill when you sit down.
 10. Start the engine and follow the method for riding downhill.
1. Shift down and accelerate before you start climbing; then maintain a steady pace.
 2. Lean as far forward as possible. For steeper hills, come off your seat to stand and lean forward.
 3. If you lose speed, release the throttle (so your front tires don't lift), **OR**
 4. If that doesn't work and you still have forward motion and the terrain permits, do a U-turn, go back down, and try climbing again, **OR**
 5. If you have lost all forward motion, follow the K-turn procedure.

Riding Uphill

Many accidents happen while riding on hills and as a result of the ATV rolling or flipping. So, obviously, use extreme caution and follow this method for riding uphill.

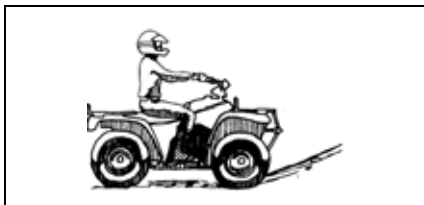

ATV-0019



ATV-0032



ATV-0033

NEVER OPERATE UP OR DOWN HILLS STEEPER THAN 25°



Riding Downhill

Success in riding downhill depends on how well you know your brakes — take it easy on them, or you could flip over.

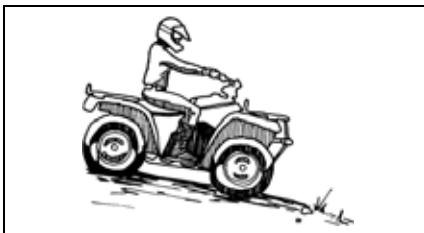

ATV-0018



ATV-0030

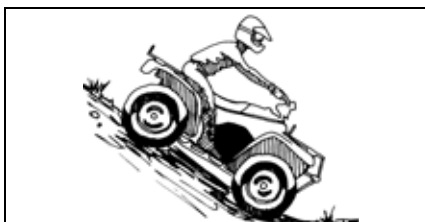

ATV-0031

1. Shift your body weight as far back on the seat as possible.
2. Keep it in a low gear; stay out of neutral.
3. Lightly apply the brake and ease up on the throttle.

Sidehilling/Traversing

Sidehilling is considered an advanced skill; it's really tricky and unpredictable. So, whether your skills are advanced or not, try to avoid this kind of riding. If you're in a situation where you absolutely have to sidehill, follow this method:



ATV-0017



ATV-0028



ATV-0029

1. Keep your speed low and consistent.
2. Shift all your body weight to the uphill side of the seat; also, support your weight on the uphill footrest.
3. Steer like you're driving into the hill.
4. If the ATV feels like it's tipping, turn the handlebar downhill. If that's not possible because of the terrain or other conditions or if it just doesn't work, stop and get off. Dismount the ATV on the uphill side.

Swerving

Swerving is usually an emergency reaction to avoid an obstacle.

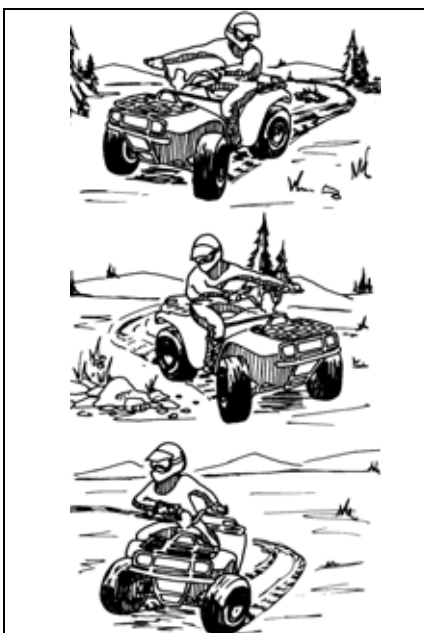

ATV-0043

1. Ease off the throttle as you approach the obstacle.
2. Turn the handlebar. At the same time, shift your weight and balance as you swerve. Use the principles of leaning, weight shifting, and balancing — shift your body weight to the inside of the turn.
3. Keep your hand off the brake until the emergency is over and you're back in control.

Crossing Obstacles

Crossing obstacles is risky; avoid it if possible. Riding over logs, rocks, and ruts means combining all the active riding skills into one big motion. Your ATV will respond differently for different obstacles (logs, ruts, etc.), but these are general guidelines for overcoming two-track (both tires contacting the obstacle at the same time) obstacles:

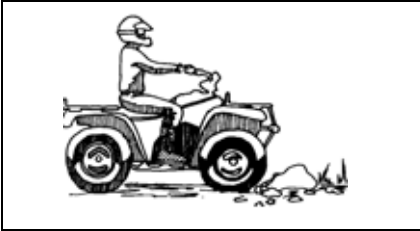

ATV-0016



ATV-0026

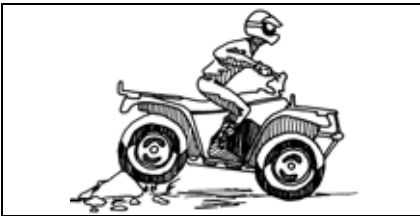

ATV-0027

1. Keep your speed way down; less than 5 mph (8 km/h).
2. Approach the obstacle head-on.
3. Come up off the seat.
4. Keep your weight on the footrests.
5. Apply a little throttle when the front tires make contact with the obstacle.
6. Lean forward and release the throttle when the front tires clear the obstacle.

7. Keep your body loose to absorb any shock.
8. If the ATV starts tipping, shift your weight to keep it in balance.

To clear a single-track (only one tire contacts) obstacle, follow the same rules except:

1. Use the ATV's momentum to clear the obstacle.
2. Don't pull up on the handlebar.
3. Don't apply the throttle.

Tips

Driving an ATV and a car have some similarities; however, there are a few situations that require special attention:

- Reversing
- Skidding or Sliding
- Parking on a Hill
- Stalling on a Hill
- Crossing Water
- Crossing Roads
- Stopping the ATV
- Stopping the Engine

Reversing

It's tough to see things behind you.

1. Go slowly. It's hard to see behind you.
2. Keep your handlebar straight.
3. Backing down hills is a bad idea; do a U-turn or K-turn instead to turn around.

WARNING

Never activate the override while the throttle is open as a loss of control may result. Use caution when using the override switch as reverse speed can greatly increase.

Skidding or Sliding

If you lose control after hitting sand, ice, mud, or water:

1. Turn your handlebar into the direction of the slide.

2. Keep your hand off the brakes until you're out of the skid.
3. Shift your weight forward.

Sometimes your ATV may not respond and goes straight ahead instead of letting you turn. Here's how to handle it:

1. Slow down.
2. Move forward on the seat.
3. Lean to inside of turn.
4. Turn handlebar.

Parking on a Hill

See Parking section on page 31.

Stalling on a Hill

If you use the right method for riding uphill, this shouldn't happen. But if you have a problem, do this:

1. If the ATV hasn't started rolling backwards yet, follow the procedure for the K-Turn, **OR**
2. If the ATV is already rolling backward, lean as far forward as possible standing up on the footrests.
3. Nice and easy, apply the hand brake lever.
4. When you come to a stop, follow the procedure for the K-turn.
5. If the ATV continues to roll backward, dismount immediately on the uphill side.

Crossing Water

Your ATV can only handle water up to its footrests. Any more than that and you risk engine damage and/or personal injury. Stay away from fast moving rivers. ATV tires can be buoyant, so if the water is too deep, you might find the ATV suddenly afloat.

1. Physically check the depth and current of the water, especially if you can't see the bottom. You're also checking for boulders, logs, or any other hidden obstacles.
2. Keep your speed slow.

3. Make sure you have a way out on the other side of the water.
4. If you get stuck in the sludge or mud, try rocking the ATV from side to side.
5. Once you've cleared the water, briefly apply the brakes to make sure they work.

⚠ WARNING

Do not operate this vehicle on a frozen body of water unless you have first verified the ice is sufficiently thick to support the vehicle, cargo, and participants. The vehicle could break through the ice causing serious injury or death.

Crossing Roads

Crossing roads on your ATV is also a bad idea, so avoid it. If you can't:

1. Stop completely on the shoulder of the road.
2. Check both directions for traffic.
3. Crossing near a blind corner or intersection is dangerous; don't do it.
4. Drive straight across to the opposite shoulder.
5. Take into account that your ATV could stall while crossing; give yourself enough time to get off the road.
6. You have to assume that oncoming cars don't see you, and if they do, they won't be able to predict your actions.
7. It's illegal to cross public roads in some places. Know your local laws.

Stopping the ATV

To stop the ATV, first release the throttle lever. Next, apply the brake.

Shutting Down Properly

This vehicle is equipped with an electronic cooling fan to aid in cooling the engine. The fan operates when coolant temperatures exceed predetermined thresholds and shuts off when coolant returns to normal temperature.

Do not shut vehicle off if the cooling fan is operating. When the fan stops, shut down vehicle.

■ **NOTE:** The vehicle should be allowed to idle until fan shuts off indicating the engine has returned to normal temperature.

CAUTION

If coolant temperature continues to increase, the vehicle should be taken to an authorized dealer for inspection.

Stopping the Engine

To stop the engine, turn the ignition switch key to the OFF position or set the emergency stop switch to the OFF position.

■ **NOTE:** Leaving the ignition switch key in the ON position could result in a discharged battery.

General Information

Control Locations and Functions

Ignition Switch Key

Two keys come with the ATV. Keep the spare key in a safe place. An identifying number is stamped on each key. Use this number when ordering a replacement key.

Ignition Switch

The ignition switch has three positions.

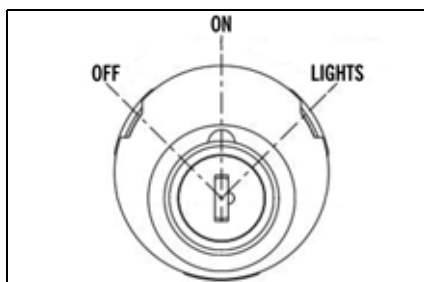

VTA-079

OFF position — All electrical circuits are off. The engine will not start. The key can be removed in this position.

ON position — The ignition circuit is complete and the engine can run. The key cannot be removed in this position.

LIGHTS position — The ignition circuit is complete and headlights and taillight are on. The key cannot be removed in this position.

CAUTION

Leaving the ignition switch in the ON or LIGHTS position for a long period of time when the engine is not running may cause the battery to discharge. Always leave the ignition switch in the OFF position when engine is not running.

Shift Lever



OHA004

This ATV has a dual-range automatic transmission with reverse and park.

Drive Select Switch

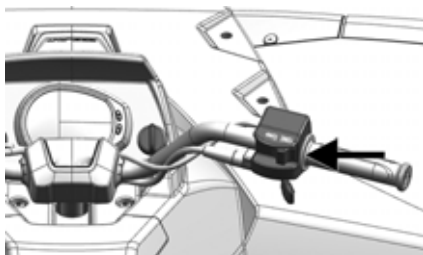

OHA006

This switch allows the operator to operate the ATV in either two-wheel drive (rear wheels) or four-wheel drive (four wheels). For normal riding on flat, dry, hard surfaces, two-wheel drive should be sufficient. In situations of aggressive trail conditions, four-wheel drive is the desired choice.

■ **NOTE:** When four-wheel drive is selected, an automatic 4WD Lock feature mechanically locks the front differential to apply equal power to both front wheels.

To engage or disengage the front wheels, move the switch to the 4WD position or to the 2WD position. The 4WD position or the 2WD position will be indicated on the LCD gauge.

If the ATV is equipped with a manual 4WD Lock feature: To engage the lock from 4WD, slide the switch up and move fully to the left. To disengage the lock, move the switch lever to the right. The lock position will be indicated on the LCD gauge.

CAUTION

Do not attempt to either engage or disengage the manual 4WD Lock while the ATV is moving.

Hand Brake Lever/Brake Lever Lock

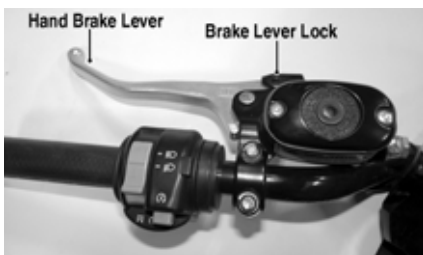

CF301A

The hand brake is considered to be the normal operating (main) brake. It should be applied whenever a braking situation is needed.

Apply the brake by compressing the brake lever toward the handlebar.

To engage and release the brake lever lock, use the following procedure:

1. Depress and hold the brake lever lock.
2. While holding in on the brake lever lock, squeeze the brake lever.

■ **NOTE:** It will click as it engages and the brake lever will not return to its released position.

3. Attempt to push the ATV. Check to make sure the brake lever lock engages properly and that the brake (when engaged) locks the wheels.

■ **NOTE:** The brake lever lock must lock the wheels. If it doesn't, take the ATV to an authorized dealer for service.

WARNING

Always check to be sure that the brake lever lock has been disengaged before operating the ATV. An accident could result if the brake lever lock is left engaged while the ATV is operated. The brake may relax if left engaged for a long period of time. This could cause an accident; therefore, do not leave the ATV on a hill depending on the brake lever lock. Always block the downhill side of the wheels if leaving the ATV on a hill or park the ATV in a sidehill position.

4. Release the brake lever lock by squeezing the brake lever. It will return to its released position.

Headlight Switch

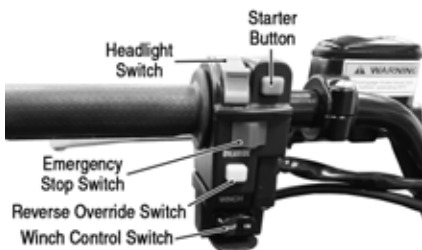

CF295C

Base and XT

With the ignition switch in the LIGHTS position, use the headlight switch to select the high or low headlight beam.



XR071B

Limited (LTD), Special Edition (SE), and Black Hills Edition

With the ignition switch in the LIGHTS position, use the headlight switch to select LED accent only, LED accent with low beam, or LED accent with high beam.

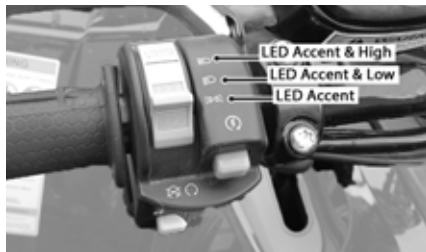

XR070C

Emergency Stop Switch

OFF position — The ignition circuit is off. The engine cannot be started or will not run. If the emergency stop switch is used to stop engine without turning off ignition switch, the battery may discharge.

RUN position — The ignition circuit is on. The engine can start and run.

In an emergency, slide the switch to the OFF position to stop the engine. Apply the brakes to stop the wheels.



XR521

Starter Button

Pushing in on this button activates the starter motor. Before starting the engine, make sure the ignition switch is in the ON position, the transmission is in neutral or park, and the brake lever lock is engaged.

■ **NOTE:** This ATV has safety interlock switches which prevent the starter motor from activating when the transmission is not in neutral or park. To start the ATV while in gear, depress the rear foot brake or compress the brake lever; then depress the starter button.

Reverse Override Switch

This ATV is equipped with a reverse speed limiter system. When additional RPM is needed in reverse, depress and hold the override switch.

■ **NOTE:** The reverse override switch is active in 2WD and 4WD.

⚠ WARNING

Never activate the override switch while the throttle is open as a loss of control may result. Use caution when using the override switch as reverse speed can greatly increase.

Throttle Lever

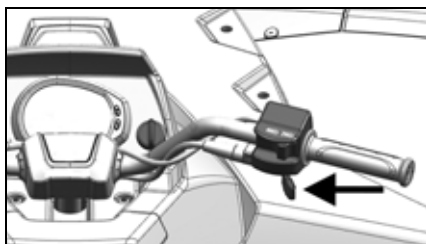

OHA007

Control engine RPM with the position of the throttle lever. Operate this lever with the thumb. Pushing it forward increases engine RPM and allowing it to retract decreases engine RPM.

Throttle Limiter Screw

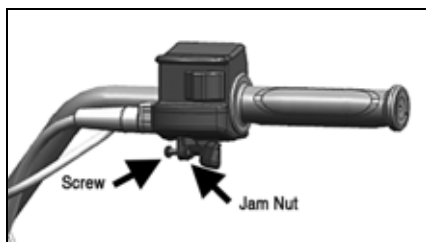

OHA008

Throttle lever travel may be limited by adjusting the throttle limiter screw. The throttle limiter should be adjusted according to the operator's skill and experience. To adjust the throttle limiter, use the following procedure:

1. Loosen the jam nut.
2. Turn the throttle limiter screw clockwise to decrease engine RPM maximum or counterclockwise to increase engine RPM maximum.
3. Tighten the jam nut securely.

■ **NOTE: The ATV is equipped with an RPM limiter that retards ignition timing when maximum RPM is approached. When the RPM limiter is activated, it could be misinterpreted as a high-speed misfire.**

Rear Foot Brake

Pressing the rear foot brake downward will apply the brake to the rear wheels in 2WD and rear wheels plus one front wheel in 4WD.

Power Steering

Certain ATV models have an Electronic Power Steering (EPS) system to reduce steering effort and driver fatigue over a broad range of operating conditions.

The EPS system engages when the ignition switch is turned to the ON position and disengages after approximately five minutes (to conserve battery power) if the engine is not running.

This system is entirely maintenance-free; no adjustment or servicing is required. There are no fluids to check or change, and the EPS system is entirely self-contained and sealed to protect it from the elements.

The EPS system is battery system powered; therefore, the battery must be in good condition and fully charged. Power delivery and overload protection is provided by an EPS relay and 30-amp fuse located under the passenger seat in the Power Distribution Module (PDM).

The system is self-monitored and will display a malfunction code on the LCD gauge/speedometer should an EPS system control circuit problem occur. Do not operate the vehicle with an EPS malfunction code displayed.

Code	Fault Description
C1301	Over Current
C1302	Excessive Current Error
C1303	Torque Sensor Range Fault
C1304	Torque Sensor Linearity Fault
C1305	Rotor Position Encoder
C1306	System Voltage Low
C1307	System Voltage High
C1308	Temperature Above 230° F (110° C)
C1309	Temperature Above 248° F (120° C)
C1310	Vehicle Speed High
C1311	Vehicle Speed Low
C1312	Vehicle Speed Faulty
C1313	Engine RPM High
C1314	Engine RPM Low
C1315	Engine RPM Faulty
C1316	EEPROM Error
C1317	CAN Bus Error
C1318	Internal CRC Error
C1319	Boot Counter Exceeded
C1320	Incorrect Vehicle Speed-to-RPM Ratio
C1321	Vehicle Speed Erratic
C1322	Engine RPM Lost
C1323	"EPS OFF" Gauge Display
C1324	Loss of CAN Communication with EPS Unit
C1325	Dual Loss
C1326	Rotor Position Encoder
C1327	Voltage Converter Error (Low)
C1328	Voltage Converter Error (High)
C1329	Internal Data Error

■ **NOTE:** Turn the key switch to the OFF position then back to the ON position to reset the malfunction code. If the code continues to be displayed, take your ATV to an authorized dealer for EPS system servicing before resuming operation.

CAUTION

Never operate this ATV with an EPS code indicated on the LCD gauge/speedometer. This indicates a malfunction in the EPS system control circuit and could result in a loss of power steering assist.

In the event of electrical power failure, the EPS system becomes disabled (similar to an automobile with the engine shut off). Steering effort increases but steering control can be maintained.

Speedometer/LCD Gauge

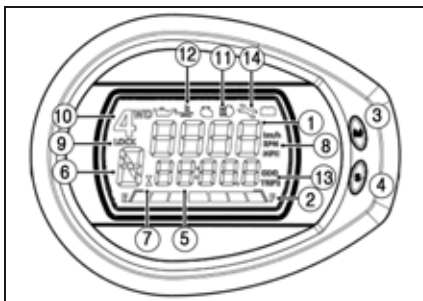

OHA040

1. Speedometer/Tachometer/Condition Warning Display — Indicates the approximate vehicle speed (MPH or km/h) or RPM, and indicates a system error condition requiring attention.

Whenever a low voltage condition (less than 9 DC volts) or a high voltage condition (greater than 16 DC volts) is detected, the LCD will go blank and “VOLT” will flash. When voltage returns to normal, the gauge must be reset by turning the ignition key to the OFF position and then to the ON position.

A diagnostic trouble code (DTC) will flash on the LCD whenever an EFI system error is detected. After 30 seconds, the gauge will return to normal, but the code will continue to flash until the malfunction is corrected.

■ **NOTE:** Take the ATV to an authorized dealer as soon as possible to have the error corrected and the system error reset.

2. Fuel Level Display — Shows the approximate amount of gasoline in the gas tank.

■ **NOTE:** When the fuel level indicator flashes, approximately 3.5 L (0.92 U.S. gal) of gasoline remains in the tank.

3. Mode Button — Press and release to alternate between vehicle speed and RPM. Press and hold to switch between MPH and km/h.

4. Set/Reset Button — Press and release to alternate between Odometer, Trip 1, Trip 2, Engine Hour Meter, and Clock. Press and hold while Trip 1 or Trip 2 are selected to clear the selected trip data. The odometer cannot be reset.

5. Odometer/Trip Meter/Clock/Engine Hour Meter Display — Shows total distance the vehicle has traveled or one of two trip meters used to measure trips or trip legs corresponding to the vehicle speed function selected (miles when MPH or kilometers when km/h). The clock indicates time in the 12-hour mode. The engine hour meter indicates the total time the vehicle's engine has been running and cannot be reset to zero. To set the clock, use the following procedure:

- A. With the ignition switch ON, press and release the Mode Button (3) until the Clock/Engine Hour Meter (1) is displayed; then (if necessary) press and release the Set/Reset Button (4) to the clock display.

- B. Press and hold Set/Reset Button (4) until minutes stop scrolling and the hour display starts to scroll. Momentarily release when correct hour is displayed; then repeatedly press and release Set/Reset Button until correct minutes are displayed.

■ **NOTE:** Approximately two seconds after releasing either Button, the LCD will return to normal operation.

■ **NOTE:** Clock memory power is supplied through the 15-amp accessory fuse and verified during gauge “power-up” and reset. In the event of clock memory power failure (blown fuse, etc.), the gauge will “power-up,” reset, and shut down repeatedly until clock memory power is restored. Always check the 15-amp accessory fuse if this gauge condition is noted.

■ **NOTE:** The engine hour meter will not activate until engine speed exceeds 500 RPM.

6. Gear Position Display — Shows which gear is selected: L (low range)/H (high range)/N (neutral)/R (reverse)/P (park).

■ **NOTE:** An E will be displayed if there is an error caused by a no-shift position signal.

7. Engine Hour Meter Indicator — Indicates engine hour meter mode is selected on the display.
8. Speedometer/Tachometer Indicator — Indicates which mode (MPH, km/h, or RPM) is displayed.
9. 4WD Lock Indicator — Displays LOCK when the front differential lock has been engaged.

10. Drive Select Indicator — Displays 4WD when selected by the drive select switch or when the 4WD lock is engaged. The display is blank when in 2WD.

11. High Beam Indicator — Appears when the headlights are on high beam.

12. Temperature Indicator — The temperature icon will flash to indicate a high engine temperature condition. The icon should not be visible during normal operation.

CAUTION

Continued operation with high engine temperature may result in engine damage or premature wear.

■ **NOTE:** High engine RPM, low vehicle speed, or heavy load can raise engine temperature. Decreasing engine RPM, reducing load, and selecting an appropriate transmission gear can lower the temperature.

■ **NOTE:** Debris in front of the engine (or packed between the cooling fins of the radiator) can reduce cooling capacity. Using a garden hose, wash the radiator and the engine to remove any debris restricting air flow.

CAUTION

Do not use a pressure washer to clean the radiator core is not recommended. The pressure may bend or flatten the fins causing restricted air flow, and electrical components on the radiator could be damaged. Use only a garden hose with spray nozzle at normal tap pressure.

13. Odometer/Trip Meter Indicator — Displays which mode (ODO, Trip 1, or Trip 2) is selected.

14. Wrench Indicator — Displayed in conjunction with a diagnostic trouble code (DTC) whenever an EFI system error is detected.

Diagnostic Trouble Codes

Display	Fault Description
C0063	Tilt Sensor Circuit High
C0064	Tilt Sensor Circuit Low/SG/Open
C1263	Backup/Reverse Circuit Open
C1264	Backup/Reverse Buzzer Circuit High
C1265	Backup/Reverse Circuit Low/SG
C1400	Fuel Level Sensor Circuit Open
C1418	Memory Power Failure
P0030	O2 Heater Intermittent/Open
P0031	O2 Heater Low/SG
P0032	O2 Heater High/SP
P0107	MAP Sensor Circuit Low/SG/Open
P0108	MAP Sensor Circuit High/SP
P0112	Intake Air Temp Sensor Circuit Low/SG
P0113	Intake Air Temp Sensor Circuit High/Open
P0114	Intake Air Temp Sensor Circuit Intermittent
P0116	Engine Coolant Temp Sensor Circuit Range/Performance
P0117	Engine Coolant Temp Sensor Circuit Low/SG
P0118	Engine Coolant Temp Sensor Circuit High/Open/SP
P0119	Engine Coolant Temp Sensor Circuit Intermittent
P0121	Throttle Position Sensor Range/Performance
P0122	Throttle Position Sensor Circuit Low/SG
P0123	Throttle Position Sensor Circuit High
P0130	O2 Sensor Intermittent/Open
P0131	O2 Sensor Low/SG or Air-Leak
P0132	O2 Sensor High/SP
P0171	O2 Feedback Below Minimum Correction
P0172	O2 Feedback Exceeds Maximum Correction
P0219	Engine Over-Speed Condition
P0231	Fuel Pump Relay Circuit Low/SG/Open
P0232	Fuel Pump Relay Circuit High
P0233	Fuel Pump Relay Circuit
P0261	Cylinder #1 Fuel Injector Circuit Low/SG
P0262	Cylinder #1 Fuel Injector Circuit High
P0263	Cylinder #1 Fuel Injector Balance/Open
P0336	Crankshaft Angle Sensor Synchronization

Display	Fault Description
P0337	Crankshaft Angle Sensor Circuit/SG
P0339	Crankshaft Angle Sensor Intermittent/Erratic
P0444	Intermittent/Erratic Voltage Condition on EVAP Purge Control Valve Circuit Output
P0458	Low Voltage Situation on EVAP Purge Control Valve Circuit Output
P0459	High Voltage Situation on EVAP Purge Control Valve Circuit Output
P0480	Fan-Primary/Right Relay Control Circuit
P0481	Fan-Secondary/Left Relay Control Circuit High
P0482	Fan-Secondary/Left Relay Control Circuit Low/SG/Open
P0483	Fan-Secondary/Left Relay Control Circuit
P0484	Fan-Primary/Right Relay Control Circuit High
P0485	Fan-Primary/Right Relay Control Circuit Low/SG/Open
P0500	Vehicle Speed-Sensor
P0508	Idle Air Control System Circuit Low/SG
P0509	Idle Air Control System Circuit High/Open
P0520	Engine Oil Sensor/Switch
P0562	System Voltage Low
P0563	System Voltage High
P0601	ECM CAN Communication Shutdown
P0615	Starter Relay Circuit
P0616	Starter Relay Circuit Low
P0617	Starter Relay Circuit High
P0630	VIN Not Programmed or Incompatible
P0642	Sensor Power Circuit Low
P0643	Sensor Power Circuit High
P2300	Ignition Coil #1 Primary Circuit Low/SG/Open
P2301	Ignition Coil #1 Primary Circuit High
P2531	Ignition Switch Circuit Low
P2532	Ignition Switch Circuit High
FUEL OFF	Tilt Sensor Activation Code

■ **NOTE:** Take the vehicle to an authorized dealer to have the error corrected and the system error reset as soon as possible.

Oil Level Stick

There is an oil level stick for checking the engine oil level. To check the oil level, use the following procedure:

■ **NOTE:** The ATV should be on level ground when checking the engine oil level.

1. Unscrew the oil level stick and wipe it with a clean cloth.
2. Install the oil level stick.

■ **NOTE:** The oil level stick should be threaded in for checking purposes.

3. Remove the oil level stick; the engine oil level should be within the operating range as indicated.



GZ461A

CAUTION

Do not overfill the engine with oil. Always make sure the oil level is within the operating range.

Seat Latch

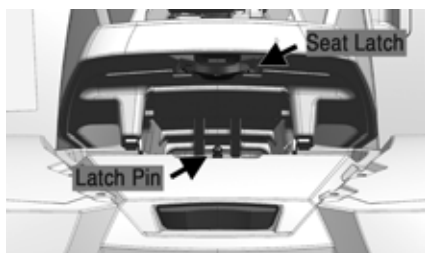

OHA010

1. To remove the seat, lift up on the latch release (located at the rear of the seat); then raise the rear of the seat and slide it rearward.

2. To lock the seat into position, slide the front of the seat into the seat retainers, line up seat latch and latch pin and push down firmly on the rear of seat. The seat should automatically lock into position.

WARNING

Make sure the seat is secure before mounting the ATV. Severe personal injury may result if the seat is not properly secured.

Safety Flag Bracket

A bracket is provided for mounting a flag at the rear of the ATV.

Rack Loading (Front and Rear)

The front rack and rear rack are designed to carry specified load capacities. Always refer to the ATV Load Capacity Ratings chart for proper capacities.

WARNING

Make sure the loads on the front and rear racks will not interfere with the ATV controls or obstruct the view of the operator. Also, make sure the loads are evenly distributed, properly secured, and will not shift while operating the ATV.

Trailing and Towing

WARNING

Never use the racks as a towing or trailering point.

This vehicle is equipped with a frame-mounted receiver for a standard 2-in (5.1 cm) receiver hitch. The standard receiver hitch must be purchased separately.

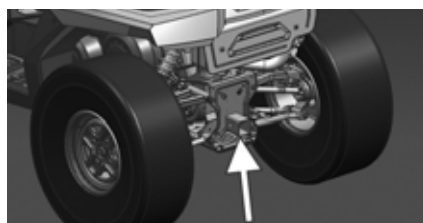

OHA009

When loading a trailer properly, two items are critical: Gross Trailer Weight (the weight of the trailer plus cargo) and Trailer Tongue Weight.

⚠ WARNING

Make sure that the load in the trailer is properly secured and will not shift while the ATV is moving. Also, do not overload the trailer.

⚠ WARNING

Never exceed any of the ATV weight restrictions.

Trailer Tongue Weight is the downward force exerted on the hitch by the trailer coupler when the trailer is fully loaded and the coupler is at its normal towing height. Refer to the Load Capacity Ratings chart for tongue weight information.

Always maintain a low speed when trailering and towing. Avoid sudden acceleration, quick maneuvers, and sudden stops. Braking will be affected when towing a trailer; allow more stopping distance.

⚠ WARNING

Use extra caution when towing a trailer. Never tow a trailer without a rigid tongue. Never exceed 10 mph (16 km/h). Avoid uneven surfaces. Do not tow on hills.

⚠ WARNING

Only tow people when towing a disabled vehicle with operable brakes and steering or on a trailer designed for passengers that has a rigid tow bar.

Transporting

When transporting the ATV, the ATV must be in its normal operating position (on all four wheels) and the following procedure must be used.

1. Engage the brake lever lock and place the transmission in park.

CAUTION

Failure to engage the brake lever lock and place the transmission in park could result in the ATV rolling off the trailer in the event of tie-down strap failure.

2. Secure the ATV with load rated hold-down straps.

■ **NOTE:** Suitable hold-down straps are available from your authorized dealer. Ordinary rope is not recommended because it can stretch under load.



OHA012



OHA011

CAUTION

If using additional hold-down straps in any other areas, care must be taken not to damage the ATV.

Gasoline—Oil—Lubricant Filling Gas Tank

⚠ WARNING

Always fill the gas tank in a well-ventilated area. Never add gasoline to the ATV gas tank near any open flames or with the engine running or hot. **DO NOT SMOKE** while filling the gas tank.

Since gasoline expands as its temperature increases, the gas tank must be filled to its rated capacity only. Expansion room must be maintained in the tank particularly if the tank is filled with cold gasoline and then moved to a warm area.

Allow the engine to cool before filling the gas tank. Care must be taken not to overfill the tank. If overfilled, gas may leak onto the engine creating a fire hazard.

⚠ WARNING

Do not over-flow gasoline when filling the gas tank. A fire hazard could materialize. Always allow the engine to cool before filling the gas tank.

⚠ WARNING

Do not overfill the gas tank.

Tighten the gas tank cap securely after filling the tank.

Recommended Gasoline

The recommended gasoline to use in this ATV is 87 minimum octane regular unleaded. In many areas, oxygenates are added to the gasoline. Oxygenated gasolines containing up to 10% ethanol or 5% methanol are acceptable gasolines.

When using ethanol-blended gasoline, it is not necessary to add a gasoline antifreeze since ethanol will prevent the accumulation of moisture in the fuel system.

CAUTION

Do not use white gas. Only approved gasoline additives should be used.

Recommended Engine/Transmission Oil

CAUTION

Any oil used in place of the recommended oil could cause serious engine damage. Also, not recommended are racing, vegetable, non-detergent, and castor-based oils.

The recommended oil to use is ACX All Weather Synthetic engine oil, which has been specifically formulated for use in this engine. Although ACX All Weather Synthetic engine oil is the only oil recommended for use in this engine, use of any API-certified SM 0W-40 oil is acceptable.

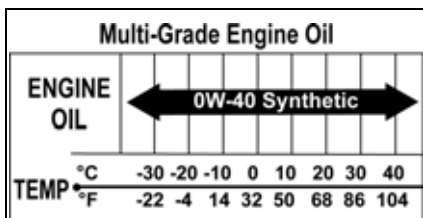

OILCHARTJ

Recommended Front Differential and Transaxle Lubricants

■ **NOTE:** The manufacturer recommends the use of genuine lubricants.

The recommended front differential (actuator on gas cap side) lubricant is SAE-approved 80W-90 hypoid. This lubricant meets all the lubrication requirements of the front differential (actuator on gas cap side).

CAUTION

Any lubricant used in place of the recommended lubricant could cause serious damage to the front differential damage.

The recommended transaxle/front differential (actuator on foot brake side) lubricant is Synthetic Extreme Pressure Transaxle Fluid. This lubricant meets all the lubrication requirements of the transaxle/front differential (actuator on foot brake side).

CAUTION

Any lubricant used in place of the recommended lubricant could cause serious damage to the transaxle/front differential.

Engine Break-In

After the completion of the break-in period, the engine oil and oil filter should be changed. Other maintenance after break-in should include checking of all prescribed adjustments and tightening of all fasteners. At the discretion and expense of the owner/operator, the ATV may be taken to an authorized dealer for this initial service

New ATVs and renewed ATV engines require a “break-in” period. The first month is most critical to the life of this ATV. Proper operation during this break-in period will help ensure maximum life and performance from the ATV.

During the first 10 hours of operation, always use less than 1/2 throttle. Varying the engine RPM during the break-in period allows the components to “load” (aiding the engine/transmission component mating process) and then “unload” (allowing components to cool). Although it is essential to place some stress on the engine components during break-in, care should be taken not to overload the engine too often. Do not pull a trailer during the break-in period.

When the engine starts, allow it to warm up properly. Idle the engine several minutes until the engine has reached normal operating temperature. Do not idle the engine for excessively long periods of time.

Burnishing Brake Pads

Brake pads must be burnished to achieve full braking effectiveness. Braking distance will be extended until brake pads are properly burnished.



WARNING

Failure to properly burnish the brake pads could lead to premature brake pad wear or brake loss. Brake loss can result in severe injury.

To properly burnish the brakes, use the following procedure:

1. Choose an area sufficiently large to safely accelerate ATV to 30 mph (48 km/h) and brake to a stop.
2. Accelerate to 30 mph (48 km/h); then compress brake lever to decelerate to 0-5 mph (0-8 km/h).
3. Repeat procedure 20 times.



WARNING

Do not attempt sudden stops or put yourself into a situation where a sudden stop will be required until the brake pads are properly burnished.

General Maintenance

■ **NOTE: Proper maintenance of the ATV is important for optimum performance. Follow the Maintenance Schedule and all ensuing maintenance and care instructions/information.**

■ **NOTE: Proper maintenance procedures for each item can be found on the corresponding page indicated.**

If, at any time, abnormal noises, vibrations, or improper functioning of any component of this ATV is detected, **DO NOT OPERATE THE ATV.** Take the ATV to an authorized dealer for inspection and adjustment or repair.

If the owner/operator does not feel qualified to perform any of these maintenance procedures or checks, take the ATV to an authorized dealer for professional service.

Maintenance Schedule					
Item	Page	Initial Service (100 mi./ 160 km)	1 month	3 months	6 months
Battery	59	I	I		
* Engine nuts and bolts	—	I			I
Spark plug	61	I		I	I
	61, 28	Replace every 4000 miles (6400 km) or 18 months			
Liquid cooling system	52	I	Inspect every time before riding		
Throttle cable	53, 62	I	Inspect every time before riding		
Gas hoses	58	I	Inspect every time before riding		
Engine/transmission oil and filter	53, 28	R		R**	
Air Filter/housing drain	62	I	Inspect every time before riding		
Gear lubricant (Front differential/transaxle)	54-56, 28	Replace after first 50 hours or 500 miles (800 km)			I
	54-56, 28	Replace every 400 hours or 4000 miles (6400 km)			
V-Belt	64	I			I
Spark arrester/muffler	65				C
Tires/air pressure	64, 28	I	Inspect every time before riding		
* Brake components	57	I	Inspect every time before riding		
Brake fluid	57	I	Inspect every time before riding		
Brake hoses	57	I	Inspect every time before riding		
* Steering	—	I	Inspect every time before riding		
* Suspension (Ball joint boots, drive axle boots front and rear, tie rods, differential and transaxle bellows)	—	I	Inspect every time before riding		
* Chassis nuts and bolts	—	I	T		
Frame/welds/racks	—	I			I
Electrical connections	—	I			I
Headlight/taillight/brake light	66	I	Inspect every time before riding		
Wheel lug nuts	65	I	I		

I = Inspect and clean, adjust, lubricate, replace as necessary; T = Tighten; R = Replace; C = Clean

* Dealer maintenance

** When using ACX All Weather Synthetic oil, oil change interval can be increased to every 1000 miles (1600 km) or every year.

Liquid Cooling System

■ **NOTE:** Debris in front of the engine or packed between the cooling fins of the radiator can reduce cooling capability. Using a garden hose, wash the radiator to remove any debris preventing air flow.

CAUTION

Do not use a pressure washer to clean the radiator core. The pressure may bend or flatten the fins causing restricted air flow, and electrical components on the radiator could be damaged. Use only a garden hose with spray nozzle at normal tap pressure.

The cooling system capacity can be found in the specifications chart. The cooling system should be inspected daily for leakage and damage. If leakage or damage is detected, take the vehicle to an authorized dealer for service. Also, the coolant level should be checked periodically.

CAUTION

Continued operation of the ATV with high engine temperature may result in engine damage or premature wear.

■ **NOTE:** High engine RPM, low vehicle speed, or heavy load can raise engine temperature. Decreasing engine RPM, reducing load, and selecting an appropriate transmission gear can lower the temperature.

When filling the cooling system, use a coolant/water mixture which will satisfy the coldest anticipated weather conditions of the area in accordance with the coolant manufacturer's recommendations. While the cooling system is being filled, air pockets may develop; therefore, run the engine for five minutes after the initial fill, shut the engine off, and then fill the cooling system to the bottom of the stand pipe in the radiator neck.

Checking/Filling

1. If equipped, remove 12 screws holding rack overmold to rack and remove overmold.

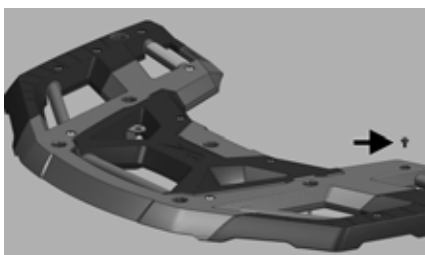

OHA051

2. Remove the rubber access plug from the front fender.

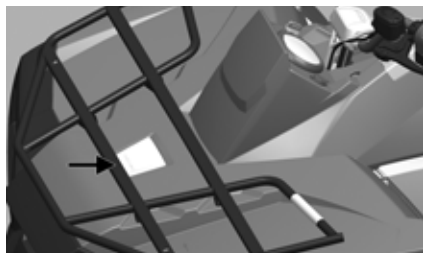

OHA013

3. Carefully rotate the radiator cap counterclockwise to release pressure; then remove the cap.

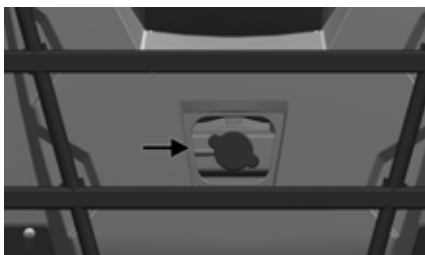

OHA014

4. Add coolant as necessary; then install the radiator cap and access plug.
5. Replace rack overmold, if equipped.

■ **NOTE:** Use a good quality, biodegradable glycol-based, automotive-type antifreeze.



WARNING

Never check the coolant level when the engine is hot or the cooling system is under pressure.

CAUTION

After operating the ATV for the initial 5-10 minutes, stop the engine, allow the engine to cool down, and check the coolant level. Add coolant as necessary.

Maintenance

When operating in muddy conditions, it is extremely important to clean the radiator core frequently. The manufacturer requires inspecting and/or flushing the radiator core before each use to prevent overheating resulting in severe engine damage. After cleaning, shine a light through the radiator core while observing from the opposite side to determine if all dirt and debris have been removed.

■ **NOTE:** It is necessary to remove four machine screws securing the protective screen to the front of the radiator and move it forward to properly flush the radiator core. Make sure to secure the screen to the radiator after cleaning.

CAUTION

Failure to remove dirt and debris from the radiator prior to operating the ATV may cause overheating resulting in severe engine damage.

CAUTION

Do not use a pressure washer to clean the radiator core. The pressure may bend or flatten the fins causing restricted air flow, and electrical components on the radiator could be damaged. Use only a garden hose with spray nozzle at normal tap pressure.

Shock Absorbers

Each shock absorber should be visibly checked weekly for excessive fluid leakage (some seal leakage may be observed but it does not indicate the shock is in need of replacement), cracks or breaks in the lower case, or a bent shock rod. If any one of these conditions is detected, replacement is necessary.

■ **NOTE:** When the ATV is operated in extremely cold weather (-23° C/-10° F or colder), a small amount of leakage may be present. Unless the leakage is excessive, replacement is not necessary.

The shock absorber has a spring force adjustment sleeve with five adjustment positions to allow the spring to be adjusted for different riding and loading conditions. If the spring action is too soft or too stiff, adjust it according to the chart.

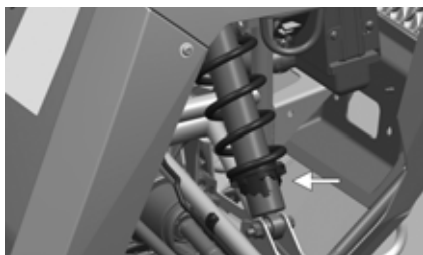

OHA015

■ **NOTE:** Before attempting to adjust suspension, clean dirt and debris from the sleeve and remove load from the suspension; then use the spanner wrench to adjust the sleeve to the desired position.

Position	Spring Force	Setting	Load	
1		Soft	Light	
2			Stiff	Heavy
3				
4				
5		Stronger		

General Lubrication

Cables

None of the cables require lubrication; however, it is advisable to lubricate the ends of the cables periodically with a good cable lubricant.

Engine/Transmission Oil and Filter

Change the engine oil and oil filter (A) at the scheduled intervals. The engine should always be warm when the oil is changed so the oil will drain easily and completely.

1. Park the ATV on a level surface.
2. Loosen the oil level stick (B). Be careful not to allow contaminants to enter the opening.

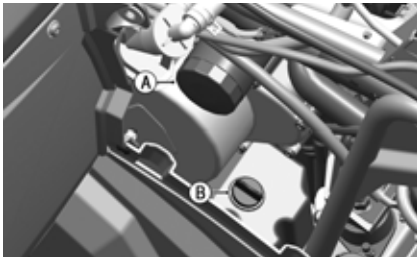

OHA016

3. Remove the drain plug (C) from the back of the engine through the access hole in skid plate and drain the oil into a drain pan.

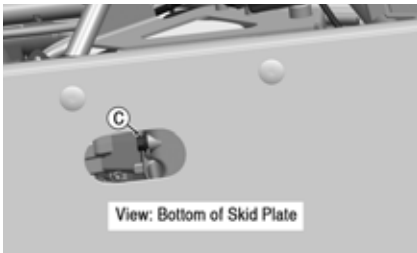

OHA017

4. Using the oil filter wrench and a ratchet handle (or a socket or box-end wrench), remove the old oil filter (A) (see illustration OHA016) and dispose of properly. Do not re-use oil filter.

■ **NOTE: Clean up any excess oil after removing the filter.**

5. Apply oil to the new filter O-ring and check to make sure it is positioned correctly; then install the new oil filter. Tighten to 10-12 ft-lb (13.5-16.3 N-m).
6. Install the engine drain plug (C) and new gasket; then tighten to 12 ft-lb (16.3 N-m).
7. Remove the oil filler cap from the top of the engine, being careful not to let contaminants enter the opening; then pour ACX All Weather Synthetic oil into the filler hole.

8. Install the level stick (B).
9. Start the engine (while the ATV is outside on level ground) and allow it to idle for a few minutes.
10. Turn the engine off and wait approximately one minute. Recheck the oil level.
11. Inspect the area around the drain plug and oil filter for leaks.

Front Differential Lubricant (Inspecting/Changing)

Inspect and change the gear lubricant in each according to the Maintenance Schedule. When changing the lubricant, check the location of the differential actuator and use specified lubricant and the following procedures:

Actuator and fill plug on gas cap side (A):
Use approved SAE 80W-90 hypoid oil.

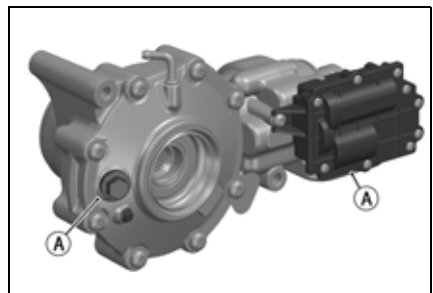

OHA158C

1. Place the ATV on level ground.
2. Remove front differential fill plug (A).

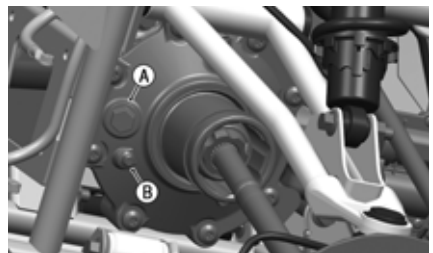

OHA018

3. Drain the oil into a drain pan by removing the front differential drain plug (C) through the access hole (D) in the skid plate. Clean away any debris that may have accumulated onto the magnetic end of the plug.

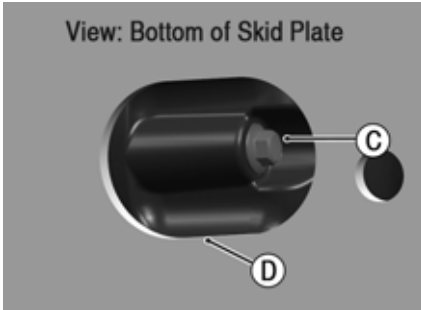

4. After all the oil has been drained, install the drain plug (C) and new O-ring; then tighten to 41 in-lb (4.6 N-m).

CAUTION

Inspect the oil for any signs of metal filings or water. If found, take the ATV to an authorized dealer for servicing.

5. Remove front differential oil level plug (B) and pour recommended oil into the fill plug hole (A) until level with bottom of oil level plug opening (refer to illustration OHA018 above).
6. Install fill plug (A) and tighten to 16 ft-lb (21.8 N-m).
7. Install oil level plug (B) and tighten to 41 in-lb (4.6 N-m).

Actuator and fill plug on foot brake side (B): Use Synthetic Extreme Pressure Transaxle Fluid.

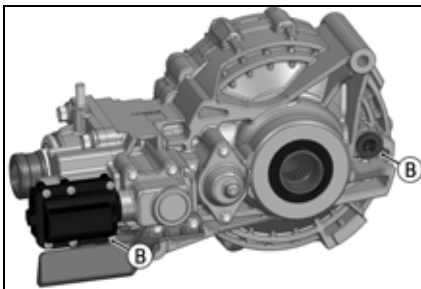

1. Place the ATV on level ground.
2. Remove front differential fill plug (A).

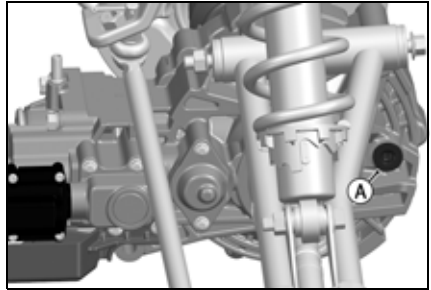

3. Drain the oil into a drain pan by removing the front differential drain plug (C) through the access hole (D) in the skid plate. Clean away any debris that may have accumulated onto the magnetic end of the plug.

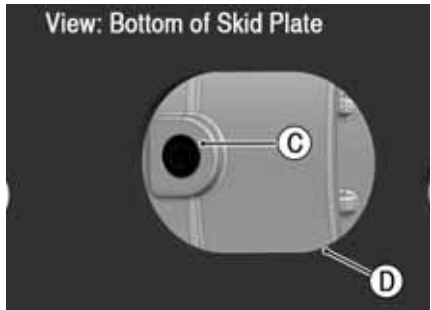

4. After all the oil has been drained, install the drain plug (C); then tighten to 44 in-lb (5 N-m).

CAUTION

Inspect the oil for any signs of metal filings or water. If found, take the ATV to an authorized dealer for servicing.

5. Pour 270 mL (9.1 fl oz) of recommended oil into the fill plug hole (A). The oil level should be within 3/16" of the fill plug threads.

■ **NOTE:** Bend down 3/16" of the end of a cable tie and use as a gauge to check fluid level.

6. Install fill plug (A) and tighten to 8.85 ft-lb (12 N-m).

Transaxle Lubricant Change

Inspect and change the lubricant according to the Maintenance Schedule. When changing the lubricant, use the appropriate lubricant and use the following procedure:

■ **NOTE:** The fill plug is located on the front right side of the transaxle.

1. Place the vehicle on a suitable stand; then remove the transaxle fill plug (A).



OHA022

2. Remove lower-right A-arm nuts and bolts and drop the A-arm.

■ **NOTE:** Remove wheel for easier access to A-arm.

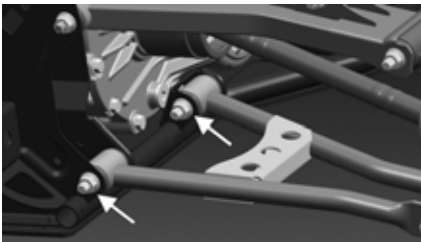

OHA021

3. Use a pry bar without sharp edges to carefully lift up on the transaxle enough to align drain plug (B) with access hole (C) in the A-arm bracket. Remove transaxle drain plug (B) through the access hole (C). Drain the oil into a drain pan positioned under the cutout (D) in the skid plate. Clean off any debris that may have accumulated onto the magnetic end of the drain plug.

CAUTION

Using a pry bar with sharp edges may result in transaxle case damage.

■ **NOTE:** Failure to align drain plug with access hole during removal and installation may cause cross threading of the plug.

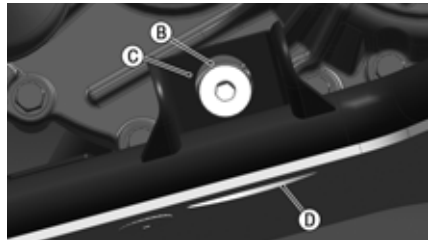

OHA020

4. After the oil has been drained, use a pry bar without sharp edges to carefully lift up on the transaxle enough to align drain plug (B) with access hole (C). Install the drain plug (B) and tighten to 16 ft-lb (21.8 N-m).

CAUTION

Using a pry bar with sharp edges may result in transaxle case damage.

■ **NOTE:** Failure to align drain plug with access hole during removal and installation may cause cross threading of the plug.

CAUTION

Inspect the oil for any signs of metal filings or water. If found, take the vehicle to an authorized dealer for servicing.

5. Add Synthetic Extreme Pressure Transaxle Fluid into the fill plug hole. The lubricant level should be approximately at the bottom of the plug hole threads.

■ **NOTE:** The manufacturer recommends the use of manufacturer-approved lubricants.

6. Install the fill plug and tighten to 16 ft-lb (21.8 N-m).
7. Re-install lower right A-arm. Tighten nuts to 42 ft-lb (56.9 N-m).
8. Re-install wheel if removed. Using a crisscross pattern, tighten the lug nuts in 20 ft-lb (27.2 N-m) increments to a final torque of 40 ft-lb (54.4 N-m) (steel wheel), 60 ft-lb (81.6 N-m) (aluminum wheel w/black nuts), or 80 ft-lb (108.8 N-m) (aluminum wheel w/chrome nuts).

Hydraulic Hand Brake

WARNING

Be sure to inspect the hydraulic brake system before each use. Always maintain brakes according to the Maintenance Schedule.

Brake Fluid

Check the brake fluid level in the brake fluid reservoir. If the level in the reservoir is not visible in the sight glass, add DOT 4 brake fluid.



CF295A

■ **NOTE:** If the sight glass appears dark, there is a sufficient amount of fluid in the reservoir.

CAUTION

Be careful not to spill any fluid when filling the brake fluid reservoir. Wipe away spilled fluid immediately.

Brake Lever Lock

■ **NOTE:** The brake lever lock must lock the wheels. If it doesn't, take the ATV to an authorized dealer for service.

Brake Hoses

Carefully inspect the hydraulic brake hoses for cracks or other damage. If found, take the ATV to an authorized dealer to have the brake hoses replaced.

Brake Pads

The clearance between the brake pads and brake discs is adjusted automatically as the brake pads wear. The only maintenance that is required is replacement of the brake pads when they show excessive wear. Check the thickness of each of the brake pads as follows:

1. Remove a front wheel.
2. Measure the thickness of each brake pad.
3. If thickness of either brake pad is less than 1.0 mm (0.039 in), take the ATV to an authorized dealer to have brake pads replaced.

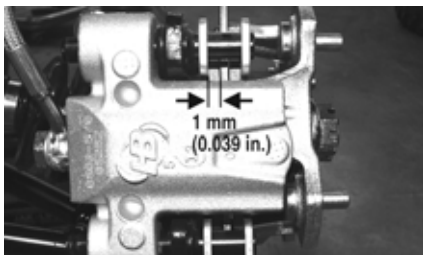

PR376B

4. Install the wheel; then using a crisscross pattern, tighten the wheel nuts in 20 ft-lb (27.2 N-m) increments to a final torque of 40 ft-lb (54.4 N-m) (steel wheel), 60 ft-lb (81.6 N-m) (aluminum wheel w/black nuts), or 80 ft-lb (108.8 N-m) (aluminum wheel w/chrome nuts).

Rear Foot Brake

The rear foot brake must be maintained to be fully functional.

WARNING

Be sure to inspect the rear foot brake system before each use. Always maintain brakes according to the Maintenance Schedule.

1. Check the brake fluid level in the reservoir. The fluid level must be maintained between the MAX and MIN level marks. If the level in the reservoir is low, add DOT 4 brake fluid.



OHA023

■ **NOTE: The brake fluid reservoir is located behind right-side panel.**

2. Press the rear foot brake several times to check for firmness.
3. If the brake is not firm, the system must be bled.

■ **NOTE: Take the ATV to an authorized dealer for this service.**

Gas Hoses

Inspect the gas hoses. Damage from aging may not always be visible.

Protective Rubber Boots

The protective boots should be inspected periodically according to the Maintenance Schedule.

Ball Joint Boots (Upper and Lower/Right and Left)



XR486A



XR487A

1. Secure the ATV on a support stand to elevate the front wheels.
2. Remove both front wheels.
3. Inspect the four ball joint boots for cracks, tears, or perforations.
4. Check the ball joint for free-play by grasping the steering knuckle and turning it from side to side and up and down.
5. If boot damage is present or ball joint free-play seems excessive, contact an authorized dealer for service.

Tie Rod Boots (Inner and Outer/Right and Left)

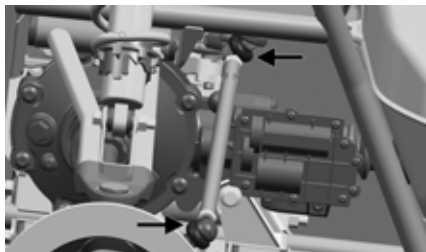

OHA033

1. Secure the ATV on a support stand to elevate the front wheels.

2. Remove both front wheels.
3. Inspect the four tie rod boots for cracks, tears, or perforations.
4. Check the tie rod end free-play by grasping the tie rod near the end and attempting to move it up and down.
5. If boot damage is present or tie rod end free-play seems excessive, contact an authorized dealer for service.

Drive Axle Boots

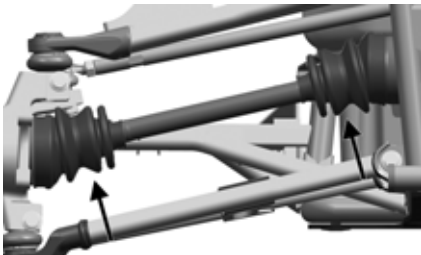

OHA032

1. Inspect all drive axle boots for cracks, tears, or perforations.
2. If boot damage is present, contact an authorized dealer for service.

Battery

Remove seat and right-side panel to access battery.

After being in service, batteries require regular cleaning and recharging in order to deliver peak performance and maximum service life. The following procedures are recommended for cleaning and maintaining a sealed battery. Always read and follow instructions provided with battery chargers and battery products.

NOTE: Refer to all warnings and cautions provided with the battery or battery maintainer/charger.

Loss of battery charge may be caused by ambient temperature, ignition OFF current draw, corroded terminals, self discharge, frequent start/stops, and short engine run times. Frequent winch usage, snowplowing, extended low RPM operation, short trips, and high amperage accessory usage are also reasons for battery discharge.

Charging/Maintenance Charging

NOTE: Use of the CTEK Multi US 800 for charging or the CTEK Multi US 3300 for battery maintenance charging is recommended. Maintenance charging is required on all batteries not used for more than two weeks or as required by battery drain.



800A

NOTE: When charging a battery in the vehicle, be sure the ignition switch is in the OFF position.

1. Clean the battery terminals with a solution of baking soda and water.

NOTE: The sealing strip should NOT be removed and NO fluid should be added.

2. Be sure the charger and battery are in a well-ventilated area. Be sure the charger is unplugged from the 110-volt electrical outlet.
3. Connect the red terminal lead from the charger to the positive terminal of the battery; then connect the black terminal lead of the charger to the negative terminal of the battery.

NOTE: Optional battery charging adapters are available from your authorized dealer to connect directly to your vehicle from the recommended chargers to simplify the maintenance charging process. Check with your authorized dealer for proper installation of these charging adapter connectors.

4. Plug the battery charger into a 110-volt electrical outlet.

5. If using the CTEK Multi US 800, there are no further buttons to push. If using the CTEK Multi US 3300, press the Mode button (A) at the left of the charger until the Maintenance Charge Icon (B) or Normal Charge Icon (E) at the bottom illuminates. the Normal Charge Indicator (C) should illuminate on the upper portion of the battery charger.

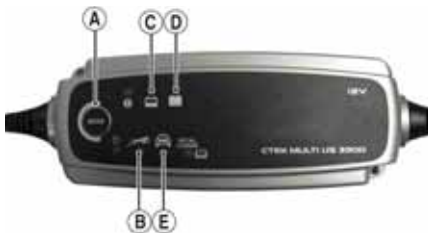

3300C

- **NOTE:** For optimal charge and performance, leave the charger connected to the battery for a minimum 1 hour after the Maintenance Charge Indicator (D) illuminates. The maintainer/charger will charge the battery to 95% capacity at which time the Maintenance Charge Indicator (D) will illuminate and the maintainer/charger will change to pulse/float maintenance. If the battery falls below 12.9 DC volts, the charger will automatically start again at the first step of the charge sequence. If the battery becomes hot to the touch, stop charging. Resume after it has cooled.

■ **NOTE:** Not using a battery charger with the proper float maintenance will damage the battery if connected over extended periods.

6. Once the battery has reached full charge, unplug the charger from the 110-volt electrical outlet.

■ **NOTE:** If, after charging, the battery does not perform to operator expectations, bring the battery to an authorized dealer for further troubleshooting.

Jump-Starting

■ **NOTE:** Do not jump-start a vehicle with a dead battery. Instead, remove the battery, service it, and correctly charge it; however, in an emergency, it may be necessary to jump-start a vehicle. If so, use the following procedure to carefully and safely complete this procedure.

WARNING

Improper handling or connecting of a battery may result in severe injury including acid burns, electrical burns, or blindness as a result of an explosion. Always remove rings and watches.

1. On the vehicle to be jump-started, remove the battery cover and any terminal boots.

WARNING

Any time service is performed on a battery, the following must be observed: keep sparks, open flame, cigarettes, or any other flame away. Always wear safety glasses. Protect skin and clothing when handling a battery. When servicing battery in enclosed space, keep the area well-ventilated. Make sure battery venting is not obstructed.

2. Inspect the battery for any signs of electrolyte leaks, loose terminals, or bulging sides. Leaking or bulging battery cases may indicate a frozen or shorted battery.

WARNING

If any of these conditions exist, DO NOT attempt a jump-start, boost, or charge the battery. An explosion could occur causing serious injury.

- Inspect the vehicle to be used for jump-starting to determine if voltage and ground polarity are compatible. The vehicle must have a 12-volt DC, negative ground electrical system.

CAUTION

Always make sure the electrical systems are of the same voltage and ground polarity prior to connecting jumper cables. If not, severe electrical damage may occur.

- Move the vehicle to be used for the jump-start close enough to ensure the jumper cables easily reach; then shift into neutral, set and lock the brakes, shut off all electrical accessories, and turn the ignition switch OFF.

■ **NOTE: Make sure all switches on the vehicle to be jump-started are turned OFF.**

- Disconnect all external accessories such as cell phones, GPS units, and radios on both vehicles.

CAUTION

Failure to disconnect electronic accessories during jump-starting may cause system damage due to power spikes.

- Attach one clamp of the positive (red) jumper cable to the positive (+) terminal (1) of the dead battery (C) being careful not to touch any metal with the other clamp; then attach the other clamp of the positive (red) jumper cable to the positive (+) terminal (2) of the good battery (B).

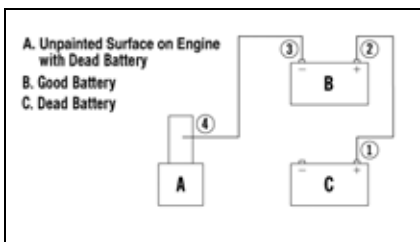

0744-527

■ **NOTE: Some jumper cables may be the same color but the clamps or ends will be color-coded red and black.**

- Attach one clamp of the negative (black) jumper cable to the negative (-) terminal (3) of the good battery (B); then attach the other clamp of the negative (black) jumper cable (4) to an unpainted metal surface (A) on the engine or frame well away from the dead battery and fuel system components.



WARNING

Never make the final connection to a battery as a spark could ignite hydrogen gases causing an explosion of the battery resulting in acid burns or blindness.

- Stand well away from the dead battery and start the vehicle with the good battery. Allow the vehicle to run for several minutes applying some charge to the dead battery.
- Start the vehicle with the dead battery and allow it to run for several minutes before disconnecting the jumper cables.
- Remove the jumper cables in opposite order of hook-up (4, 3, 2, 1). Be careful not to short cables against bare metal.

■ **NOTE: Have the battery and electrical system checked prior to operating the vehicle again.**

Spark Plug

This ATV comes equipped with a specified spark plug. See the specifications chart for the correct spark plug. To help prevent cold weather fouling, make sure to thoroughly warm up the engine before operating.

To maintain a hot, strong spark, keep the plug free of carbon.

Before removing the spark plug, be sure to clean the area around the spark plug. If you do not, dirt could enter engine when removing or installing the spark plug.

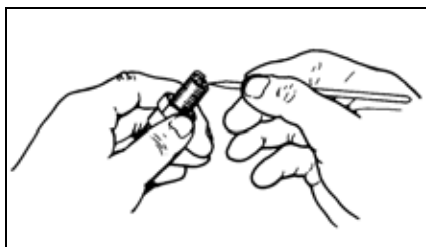

ATV-0051

Adjust the gap to specified amount (see appropriate specifications chart) for proper ignition. Use a feeler gauge to check the gap.

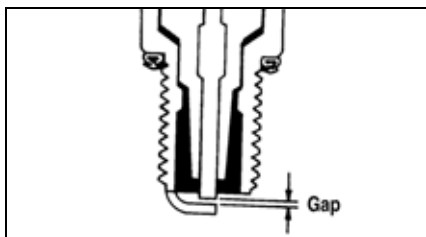

ATV0052B

A new spark plug should be tightened 1/2 turn once the washer contacts the cylinder head. A used spark plug should be tightened 1/8-1/4 turn once the washer contacts the cylinder head. Torque of 10.4-14.5 ft-lb (14.1-19.7 N-m) is recommended.

Throttle Cable Adjustment

To adjust the throttle cable free-play:

1. Loosen the jam nut from the throttle cable adjuster.
2. Slide the rubber boot away and turn the adjuster until the throttle lever has proper free-play of 3-6 mm (1/8-1/4 in).

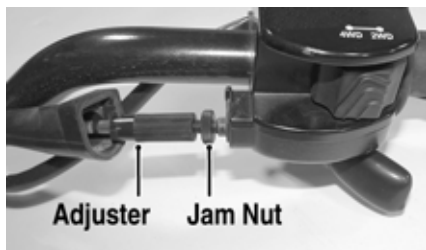

CF297E

3. Tighten the jam nut against the throttle cable adjuster securely; then slide the rubber boot over the adjuster.

Air Filter/Housing Drain

The air filter inside the air filter housing must be clean and changed periodically to provide good engine power and gas mileage, and to protect the engine from accelerated wear. If the ATV is used under normal conditions, clean or replace the filter at the intervals specified. If operated in dusty, wet, or muddy conditions, inspect and replace the filter more frequently. Use the following procedure to remove the filter and inspect and/or replace it:

CAUTION

If the ATV is used on dusty, wet, or muddy terrain, frequent inspection of the air filter is necessary. Otherwise, the motor may be damaged.

1. Remove the seat and the right-side panel from the vehicle.
2. Remove the two Torx T40 air box bolts located inside the forward storage compartment.

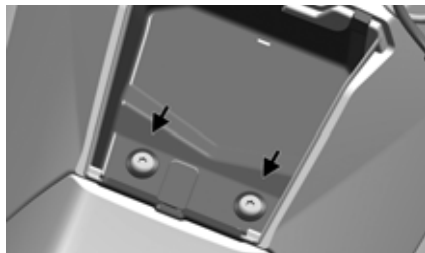

OHA024

3. If the vehicle is equipped with a winch or emergency shutoff switch, use a deep-well 10 mm socket to remove the two bolts and nuts on the gas tank bracket securing the winch solenoid or shutoff switch and move them out of the way.

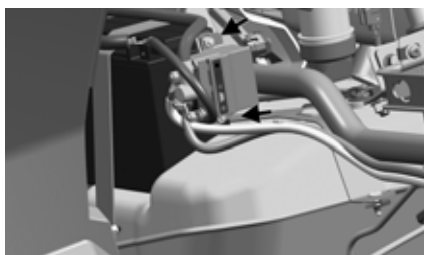

OHA025

4. Pull the yellow latch at the forward top portion of the air box lid and twist 15 degrees counterclockwise or until the lid stops rotating.

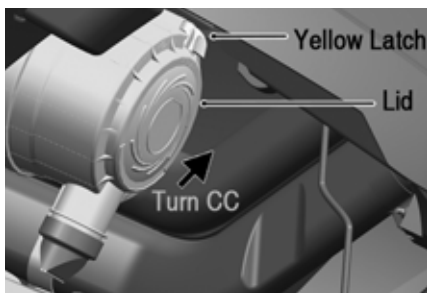

OHA026

5. While pushing the coolant lines out of the way, work the lid out of the vehicle interior through the front-right wheel well.

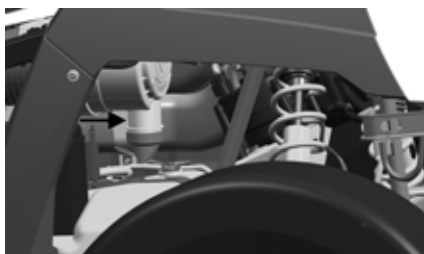

OHA027

6. After the lid is removed, check the interior portion of the lid for mud and debris to assess the state of the air filter. The center portion should be clean. Next, remove the filter through the same path as the lid and pull it out of the wheel well.

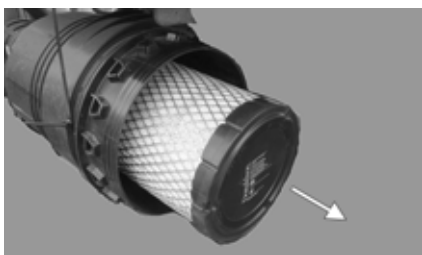

OHA028

■ **NOTE:** Once the filter has been removed, lightly tap the filter to remove any dust particles or contaminants from the filter. If the filter is excessively covered in dust particles and contaminants, it must be replaced.

CAUTION

Do not use compressed air to clean the paper element. This may cause tears in the element and allow particles to enter the combustion chamber, leading to accelerated engine wear.

7. Plug the engine intake tube with a clean shop towel. Then clean the inside of the air filter housing.

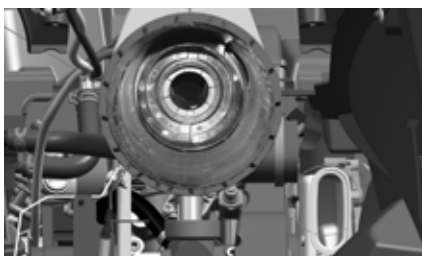

OHA029

■ **NOTE:** Verify the shop towel has been removed from the intake tube before continuing.

8. Remove the shop towel from the intake tube. Insert the filter the same way as removed making sure to push the filter all the way in toward the engine intake tube with the open end of the filter not visible at the front of the air box.

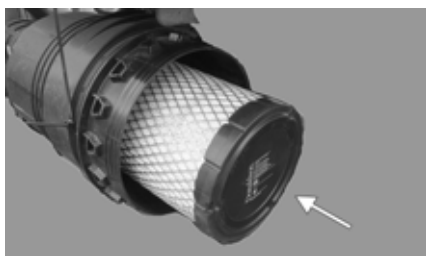

OHA030

9. While pushing the coolant lines out of the way, replace the air box lid by pushing the duckbill first and rotating the lid until it is completely around the filter. Work the lid on with the duckbill positioned 15 degrees off vertical (see illustration OHA031). Twist the lid 15 degrees clockwise until able to push the yellow latch in and lock the lid in place. When installed the lid should have the duckbill facing downward and vertical to the vehicle.

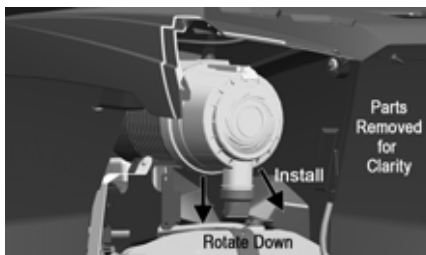

OHA031

CAUTION

A torn air filter can cause damage to the engine. Dirt and dust may get inside the engine if the element is torn. Carefully examine the element for tears before and after cleaning it. Replace a torn element with a new one.

10. Replace the winch solenoid or emergency shutoff switch (if applicable).
11. Replace the two Torx T40 bolts inside the forward storage compartment. Replace the right-side panel and the seat.

Draining V-Belt Cover

■ **NOTE:** If the ATV has been driven through water, the V-belt cover must be drained of any water.

1. Place the ATV on a level surface.
2. Remove the drain bolt from the cover and allow the water to drain out.

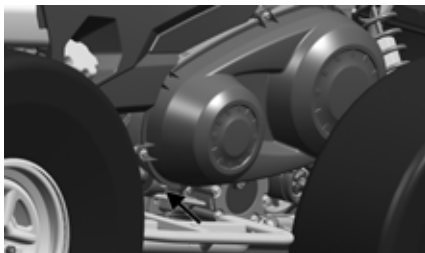

OHA035

3. Shift the range lever to the neutral position; then start the engine.
4. Increase and decrease engine RPM several times to “blow out” any water; then stop the engine.
5. Install the drain bolt and tighten securely.

■ **NOTE:** The V-belt and pulleys should be inspected every 500 miles (800 km) and the belt replaced (if necessary).

Tires

WARNING

Always use the size and type of tires as originally equipped. Refer to the appropriate Specifications table for proper tire inflation pressure, and always maintain proper tire inflation pressure.

Tire Tread Condition

The use of worn-out tires on an ATV is very dangerous. A tire is considered to be worn out when the depth of the tread is less than 3 mm (1/8 in). Be sure to replace the tires before reaching this minimum specification.

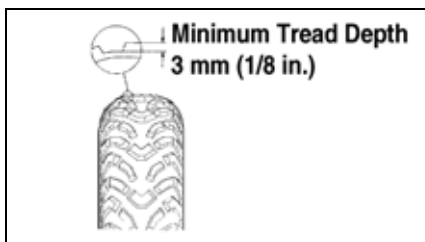

0732-649

⚠ WARNING

The use of worn-out tires can be dangerous and can increase the risk of an accident.

Tire Replacement

This vehicle has low-pressure tubeless tires. Tire replacement should be performed by a qualified tire repair station.

⚠ WARNING

Replacement tires must be the same size as originally equipped. Refer to the Specifications table on page 28 for the original tire size. Failure to follow this warning can result in the vehicle being unstable and can cause errors in the vehicle's speedometer and odometer readings.

Tubeless Tire Repair

Should a leak or flat tire occur due to a puncture, the tire may be repaired using a plug-type repair. If the damage is from a cut or if the puncture cannot be repaired using a plug, the tire must be replaced. When operating the ATV in areas where transportation or service facilities are not readily available, it is strongly recommended to carry along a plug-type repair kit and a tire pump.

Wheels

1. Park the vehicle on level ground and engage the brake lever lock.
2. Loosen the lug nuts on the wheel to be removed.
3. Elevate the vehicle.
4. Remove the lug nuts.

5. Remove the wheel.
6. Install the wheel and install the lug nuts.
7. Using a crisscross pattern, tighten the lug nuts in 20 ft-lb (27.2 N-m) increments to a final torque of 40 ft-lb (54.4 N-m) (steel wheel), 60 ft-lb (81.6 N-m) (aluminum wheel w/ black nuts), or 80 ft-lb (108.8 N-m) (aluminum wheel w/chrome nuts).
8. Lower the vehicle.

Muffler/Spark Arrester

The muffler has a spark arrester which must be periodically cleaned. At the intervals shown in the Maintenance Schedule, clean the spark arrester using the following procedure:

⚠ WARNING

Wait until the muffler cools to avoid burns.

1. Remove the cap screws securing the spark arrester assembly to the muffler.

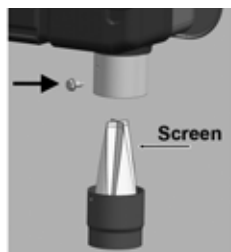

OHA034

2. Using a suitable brush, clean the carbon deposits from the screen taking care not to damage the screen.

■ NOTE: If the screen is damaged in any way, it must be replaced.

3. Install the spark arrester assembly and secure with the cap screw. Tighten cap screw to 8 in-lb (0.9 N-m).

Light Bulb Replacement Taillight

To replace the taillight, use the following procedure:

■ **NOTE:** The taillight is a non-serviceable component; it must be replaced as an assembly.

1. Disconnect the wiring harness and remove the two screws securing the taillight; then discard the old taillight.

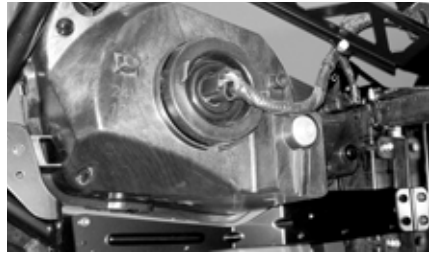

MOD046

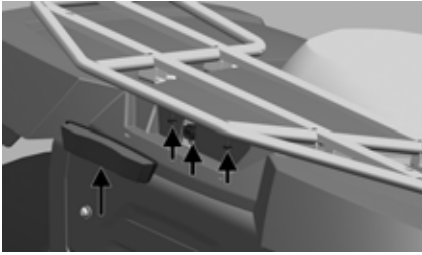

OHA036

2. Insert the new taillight into position and secure with existing screws. Tighten the screws securely; then connect the wiring harness.



MOD096

2. Remove the old H4 bulb by unlocking the spring; then insert the new bulb into headlight assembly and lock the spring to secure the bulb.

Headlight

CAUTION

Use only specified bulbs indicated in the Specifications chart as replacement bulbs.

■ **NOTE:** The bulb portion of the headlight is fragile. **HANDLE WITH CARE.** When replacing the headlight bulb, do not touch the glass portion of the bulb. If the glass is touched, it must be cleaned with a dry cloth before installing. Skin oil residue on the bulb will shorten the life of the bulb.

To replace the headlight bulb, use the following procedure:

1. Disconnect the wiring harness; then remove the rubber boot from the headlight assembly.

CAUTION

When replacing the headlight bulb, be careful not to touch the glass portion of the bulb. Grasp the new bulb with a clean rubber glove.



MOD097A

3. Install the rubber boot making sure it is sealed around the bulb and connect the wire harness.



MOD098A

- Adjust the headlight (see Checking/Adjusting Headlight Aim in this subsection).

Checking/Adjusting Headlight Aim

The headlights can be adjusted vertically and horizontally. The geometric center of the HIGH beam light zone is to be used for vertical and horizontal aiming.

- Position the ATV on a level floor so the headlights are approximately 20 ft (6.1 m) from an aiming surface (wall or similar aiming surface).

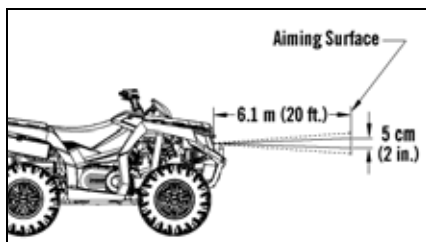

0748-548

■ **NOTE:** There should be an average operating load on the ATV when adjusting the headlight aim.

- Measure the distance from the floor to the midpoint of each headlight.
- Using the measurements obtained in step 2, make horizontal marks on the aiming surface.
- Make vertical marks which intersect the horizontal marks on the aiming surface directly in front of the headlights.
- Switch on the lights. Make sure the HIGH beam is on. DO NOT USE LOW BEAM.

- Observe each headlight beam aim. Proper aim is when the most intense beam is centered on the vertical mark 2 in (5 cm) below the horizontal mark on the aiming surface.
- With a 10 mm wrench, turn the headlight adjuster clockwise to adjust the beam down or counterclockwise to adjust the beam up.



MOD046A

Fuses

The fuses are located in a power distribution module on the right side of the ATV behind the access panel. Remove seat and the right-hand side panel to access. If there is any type of electrical system failure, always check the fuses first.

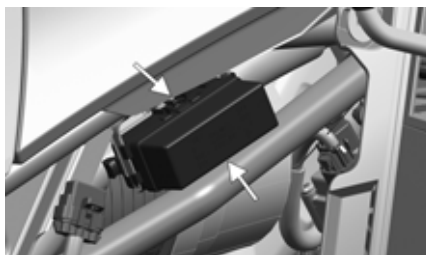

OHA037

CAUTION

Always replace a blown fuse with a fuse of the same type and rating. If the new fuse blows after a short period of use, consult an authorized dealer immediately.

■ **NOTE:** To remove the fuse, compress the locking tabs on top of the fuse cover and lift out.

10A IGN	10A POWER		START RELAY	MAIN RELAY
10A MEM	10A FUEL			
15A LIGHTS	15A SW ACC	15A FAN C/B		
30A MAIN	30A ACC	30A EPS	FAN RELAY	FUEL RELAY

OHA039

Electrical Output Terminals

Two output terminals for electrical accessories are located on the front and rear wiring harnesses. The accessory plug is located on the instrument pod.

CAUTION

Always use electrical accessories less than 180W.

Storage Compartment/Tools

A basic tool kit is provided with the ATV. Maintain the tool kit with the ATV at all times.

The storage compartment is above the engine in front of the seat.



OHA038

Preparation for Storage

CAUTION

Prior to storing the ATV, it must be properly serviced to prevent rusting and component deterioration.

The manufacturer recommends the following procedure to prepare the ATV for storage:

1. Clean the ATV thoroughly by washing dirt, oil, grass, and other foreign matter from the entire ATV. Allow the ATV to dry thoroughly. **DO NOT** get water into any part of the engine or air intake.
2. Either drain the gas tank or add a fuel stabilizer to the gas in the gas tank.
3. Clean the interior of the air filter housing.
4. Plug the hole in the exhaust system with steel wool.

5. Tighten all nuts, bolts, cap screws, and screws. Make sure rivets holding components together are tight. Replace all loose rivets. Care must be taken that all calibrated nuts, cap screws, and bolts are tightened to specifications.

6. Fill the cooling system to the bottom of the stand pipe in the radiator neck with properly mixed coolant.

7. Disconnect the battery cables (negative cable first); then remove the battery, clean the battery posts and cables, and store in a clean, dry area.

■ **NOTE: For storage, use a battery maintainer or make sure the battery is fully charged (see Battery section in this manual).**

8. Store the ATV indoors in a level position.

CAUTION

Avoid storing outside in direct sunlight and avoid using a plastic cover as moisture will collect on the ATV causing rusting.

Preparation after Storage

Taking the ATV out of storage and correctly preparing it will ensure many hours of trouble-free riding. The manufacturer recommends the following procedure to prepare the ATV:

1. Clean the ATV thoroughly.
2. Remove the steel wool from the exhaust system.
3. Check all control wires and cables for signs of wear or fraying. Replace if necessary.
4. Change the engine/transmission oil and filter.
5. Check the coolant level and add properly mixed coolant as necessary.
6. Charge the battery; then install. Connect the battery cables, making sure to connect the positive cable first.
7. Check the entire brake systems (fluid level, pads, etc.), all controls, headlights, taillight, brake light, and headlight aim. Adjust or replace if necessary.
8. Check the tire pressure. Inflate to recommended pressure as necessary.
9. Tighten all nuts, bolts, cap screws, and screws making sure all calibrated nuts, cap screws, and bolts are tightened to specifications.
10. Make sure the steering moves freely and does not bind.
11. Check the spark plug. Clean or replace as necessary.
12. Check the air filter and the air filter housing. Clean or replace as necessary.

CAUTION

Before installing the battery, make sure the ignition switch is in the OFF position.

Warranty Procedure/Owner Responsibility

At the time of sale, an ATV Rider Training Certificate and Owner Registration form must be completed by the selling dealer and consumer. The receipt of the form by Textron Specialized Vehicles (TSV) is a condition precedent to warranty coverage. It is the selling dealer's responsibility to retain and/or submit appropriate copies of the form to the appropriate place(s) to initiate warranty coverage.

The dealer will furnish to the consumer a signed copy of the form which must be presented to a dealer when requesting warranty service. The registration form is the consumer's proof of ownership and warranty eligibility. The form is used by the dealer to validate the warranty claim. You, the owner, should retain your copy of the form and keep it in a safe place.

When the need for warranty repair is suspected, the ATV should be taken to the selling dealer, if possible, who has the primary responsibility to perform warranty repairs. Subject to the limitations set forth in the Limited Warranty, in the event the selling dealer has ceased to do business, you have moved, or you are in a location away from your selling dealer, warranty may be performed by any authorized dealer.

The authorized dealer will examine the ATV or part to determine if, in its opinion, a warrantable condition exists. If a warrantable condition appears to exist, the dealer will repair or replace, at our option, free of charge, including any related labor costs, all parts that are found to be warrantable and any other parts which the warrantable part caused to be damaged. You, the owner, will then be asked to sign a warranty form to ensure TSV that the warranty work was actually performed.

It is the owner's responsibility to maintain and service the vehicle in accordance with this Operator's Manual. To protect yourself and your ATV, follow all safety and service tips. We will NOT warrant non-emissions related repairs required as a result of not performing standard operator maintenance, storage procedures, and service as outlined in the Operator's Manual.

Should you have any questions concerning the warranty, contact an authorized dealer.

U.S. EPA Emission Control Statement/ Warranty Coverage (U.S. Only)

STATEMENT/WARRANTY

Textron Specialized Vehicles (TSV) warrants to the original retail purchaser, and each subsequent purchaser, that all U.S. EPA-certified TSV vehicles are designed, built, and equipped to conform to all U.S. EPA Emission Control Regulations. Please read the following information completely.

Your authorized dealer will repair or replace any defective emission-related component at no cost to you during the warranty period. You may have non-warranty service performed by any repair establishment that uses equivalent components. The regulations provide significant civil penalties for tampering that causes your vehicle to no longer meet U.S. EPA emission standards.

TSV further warrants that the engine and its emission-related components are free from defects in materials or workmanship that could cause the engine to fail to comply with applicable regulations during the warranty period.

If you have any questions about this information, or the emission warranty coverage statement, contact your authorized dealer.

WARRANTY PERIOD

The emission warranty period for this vehicle begins on the same date as the standard warranty coverage and continues for 30 months, 5000 kilometers (3107 miles), or 500 hours, whichever comes first.

COMPONENTS COVERED

I. For exhaust emissions, emission-related components include any engine parts related to the following systems:

- | | |
|-----------------------|------------------------------------|
| Air-induction system. | Fuel system. |
| Ignition system. | Exhaust gas recirculation systems. |

II. The following parts are also considered emission-related components for exhaust emissions:

- | | |
|-------------------------|-------------------------------|
| Aftertreatment devices. | Crankcase ventilation valves. |
| Sensors. | Electronic control units. |

III. The following parts are considered emission-related components for evaporative emissions:

- | | |
|-----------------------------|----------------------------------|
| Fuel Tank. | Fuel Cap. |
| Fuel Line. | Fuel Line Fittings. |
| Clamps*. | Pressure Relief Valves*. |
| Control Valves*. | Control Solenoids*. |
| Electronic Controls*. | Vacuum Control Diaphragms*. |
| Control Cables*. | Control Linkages*. |
| Purge Valves. | Vapor Hoses. |
| Liquid/Vapor Separator. | Carbon Canister. |
| Canister Mounting Brackets. | Carburetor Purge Port Connector. |

*As related to the evaporative emission control system.

OWNER'S RESPONSIBILITIES

The owner of any vehicle warranted under this Emission Control Statement is responsible for the proper maintenance and use of the vehicle as stated in the Operator's Manual. Proper maintenance generally includes replacement and service, at the owner's choosing, such items as air filter, oil and oil filter, or any other part, item, or device related to emissions control as specified in the Operator's Manual. It is the owner's responsibility to ensure that the vehicle is used in a manner for which it was designed.

For U.S. EPA Emission Control Warranty coverage questions, contact Textron Specialized Vehicles at 218-681-9851.

California Emission Control Statement/Warranty Coverage — OHRV (U.S. Only)

STATEMENT/WARRANTY

The California Air Resources Board is pleased to explain the emission control system warranty on your OHRV. In California, new off-highway recreational vehicles must be designed, built and equipped to meet the State's stringent anti-smog standards. Textron Specialized Vehicles (TSV) must warrant the emission control system on your OHRV for the periods of time listed below provided there has been no abuse, neglect or improper maintenance of your OHRV.

Your emission control system may include parts such as the carburetor or fuel-injection system, fuel tank, fuel hoses, carbon canister, and engine computer. Also included may be hoses, belts, connectors and other emission-related assemblies. Where a warrantable condition exists, TSV will repair your OHRV at no cost to you including diagnosis, parts and labor.

WARRANTY PERIOD

For 30 months, or 2500 miles, or 250 hours, whichever comes first, except for evaporative components over the OHRV high-priced warranty value, which are covered for 60 months, or 5000 miles, or 500 hours, whichever comes first.

If any emission-related part on your OHRV is defective, the part will be repaired or replaced by TSV.

OWNER'S RESPONSIBILITIES

As the OHRV owner, you are responsible for the performance of the required maintenance listed in your owner's manual. TSV recommends that you retain all receipts covering maintenance on your OHRV, but TSV cannot deny warranty solely for the lack of receipts or for your failure to ensure the performance of a scheduled maintenance.

As an owner you are responsible for presenting your OHRV to an authorized dealership as soon as a problem exists. The warranty repairs should be completed in a reasonable amount of time, not to exceed 30 days.

As an OHRV owner, you should also be aware that TSV may deny you warranty coverage if your OHRV or a part has failed due to abuse, neglect, improper maintenance or unapproved modifications.

If you have any questions regarding your warranty rights and responsibilities, you should contact Textron Specialized Vehicles at 218-681-9851 or the California Air Resources Board at 9528 Telstar Avenue, El Monte, CA 91731.

■ NOTE: An add-on or modified part must be compliant with applicable ARB evaporative emission control standards. A violation of this requirement is punishable by civil and/or criminal punishment.

Change of Address, Ownership, or Warranty Transfer

Arctic Cat keeps on file the current name and address of the owner of this vehicle. This allows us to reach the current owner with any important safety information which may be necessary to protect customers from personal injury or property damage. Please make sure a copy of this form is completed and returned to us if you move or if the vehicle is sold to another party.

This form may also be used to transfer the unused portion of the original warranty to a second party. In order to transfer warranty, fill out this form completely; then return a copy of this form to us. We will then process the application and issue warranty for the balance of the time remaining of the original warranty. Warranty coverage is only available in the country in which the original retail purchase occurs to the original retail purchaser resident in that country or to a transferee resident in that country of the balance of the remaining warranty.

- Address Change
- Ownership Change
- Warranty Transfer

CHANGE OF ADDRESS/OWNERSHIP/ WARRANTY TRANSFER TO:

Name _____

Address _____

City/State (Province) _____

Zip Code (Postal Code) _____

Phone () _____

Email _____

Year and Model _____

Vehicle Identification Number (VIN) _____

Fold Back

Place
Stamp
Here

CHANGE OF ADDRESS/OWNERSHIP

ARCTIC CAT
PRODUCT SERVICE AND WARRANTY DEPT
PO BOX 810
THIEF RIVER FALLS MN 56701

Identification Numbers Record

This ATV has two identification numbers: Vehicle Identification Number (VIN) and Engine Serial Number (ESN). These numbers are required by the dealer to complete warranty claims properly. No warranty will be allowed if the VIN or ESN is removed or mutilated in any way.

Always provide the ATV name, Vehicle Identification Number, and Engine Serial Number when contacting an authorized dealer for parts, service, accessories, or warranty. If a complete engine must be replaced, ask the dealer to notify the manufacturer for correct registration information.

Record the Vehicle Identification Number and Engine Serial Number in the spaces provided to assist you in ordering parts from your authorized dealer or for reference in case the ATV is stolen.

1. KEY IDENTIFICATION NUMBER:

The key identification number is stamped on the key. Record this number in the space provided for reference if you ever need a new key.

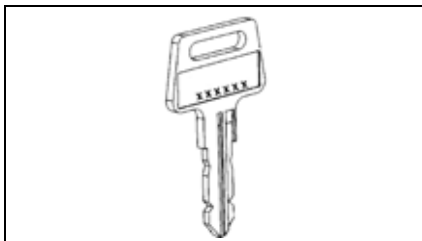

2. VEHICLE IDENTIFICATION NUMBER:

The VIN is located on the left-hand front frame support rail.

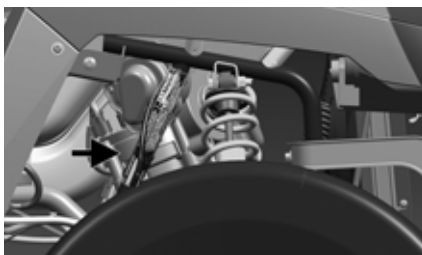

OHA043

3. ENGINE SERIAL NUMBER:

The ESN is located on the front of the engine valve cover.



OHA042



©2022 Textron Specialized Vehicles, a division of Textron, Inc.
®™ Trademarks of Arctic Cat Inc.